

Arm Energy Probe Basics



Andy Green
andy.green@linaro.org
V13 2012-08-27

Arm Energy Probe Basics

- What it is
- Quick electronics 101 recap
- Measuring around regulators
- Wiring your board for AEP usage
- Some actual measurements
- Major sources of measurement error
- Linux Commandline tool

Arm Energy Probe Basics

- What it is
- Quick electronics 101 recap
- Measuring around regulators
- Wiring your board for AEP usage
- Some actual measurements
- Major sources of measurement error
- Linux Commandline tool

Understanding what it is

- It's a 3-channel USB voltmeter, two voltages reported for each channel

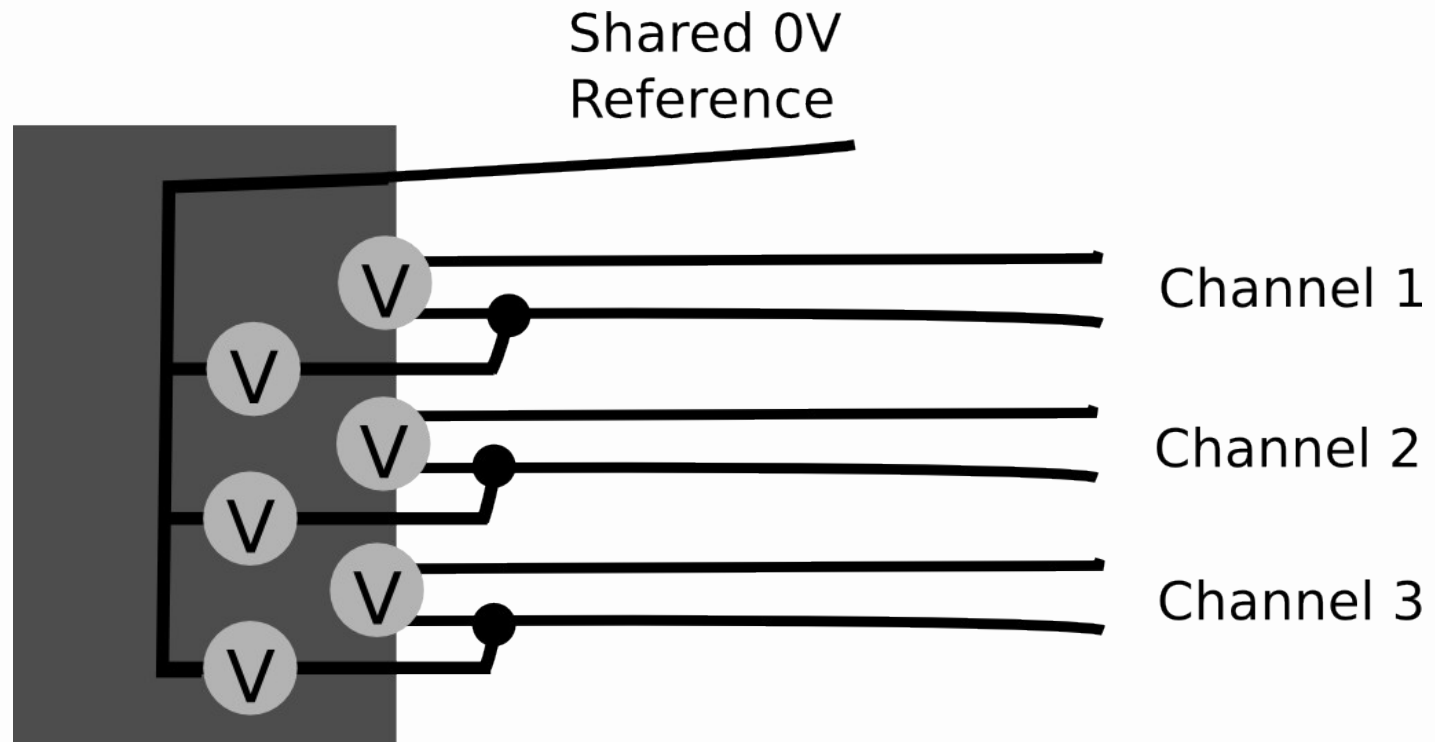

Understanding what it is

- The first voltage (up to 30V) is measured between one of the sense leads and 0V
- The other is an amplified (differential) measurement of the voltage between the two sense leads, limited to 165mV
 - These amplified channels are used to measure the voltage across shunts to calculate current
 - 165mV limit affects shunt resistance selection
 - Probe unable to measure currents below a few mA

USB side

- It has a Cortex M3 LPC1343 that appears to the host PC as a ttyACM CDC serial port class device
- Linux knows what to do with it
- Linaro has a commandline tool “arm-probe” which can drive it
- Check for other things touching ttyACM0!
 - Modem-manager from NetworkManager wants to fiddle with any ttyACM device it sees
 - Software initializes tty device to correct mode

Hardware

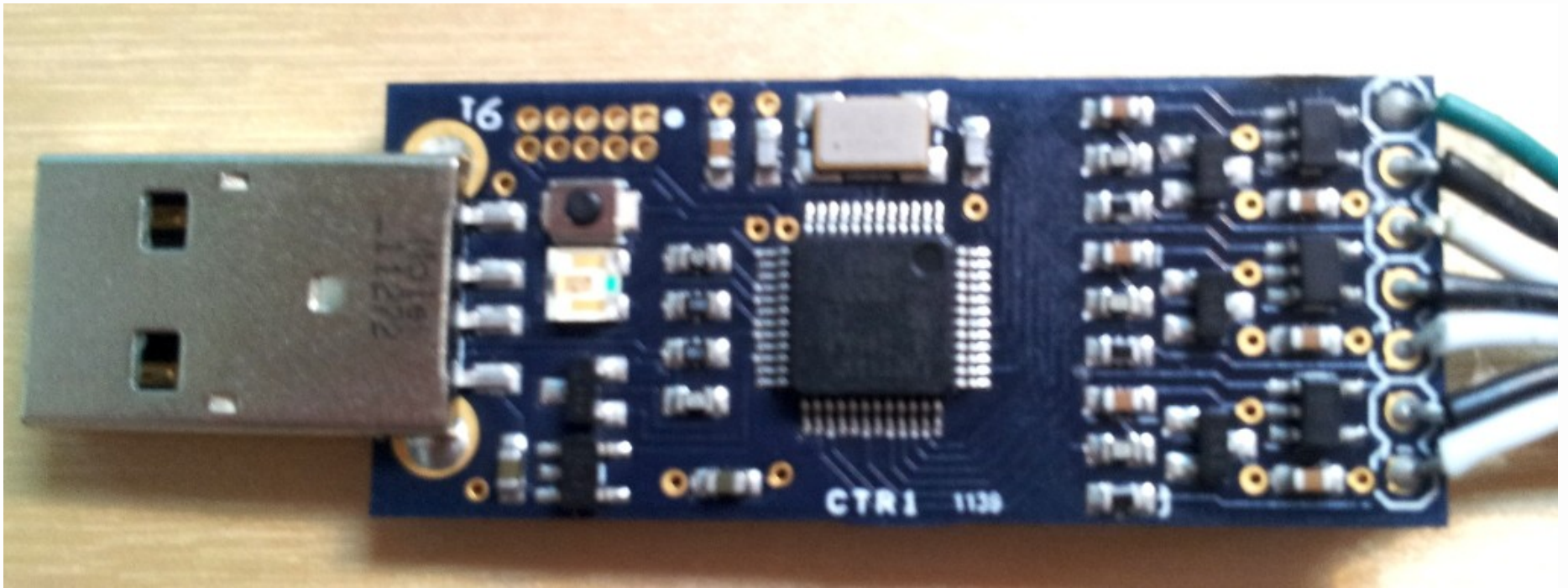

Practical problems...

- **Can only measure one channel at a time!**
 - **But we can capture one channel from all connected probes simultaneously**
 - Max 3 captures needed for any number of channels
- Probes do not have unique USB serial #
 - Cannot reliably be identified in multi-probe setup
 - Can probably be fixed by poking firmware and reflashing by hand
 - Reflashing only possible on Windows ^^

Arm Energy Probe Basics

- What it is
- Quick electronics 101 recap
- Measuring around regulators
- Wiring your board for AEP usage
- Some actual measurements
- Major sources of measurement error
- Linux Commandline tool

Voltage

- Voltage is the “potential difference” between two points, usually the power rail and a common “0V” or “ground” point, measured in Volts (V)

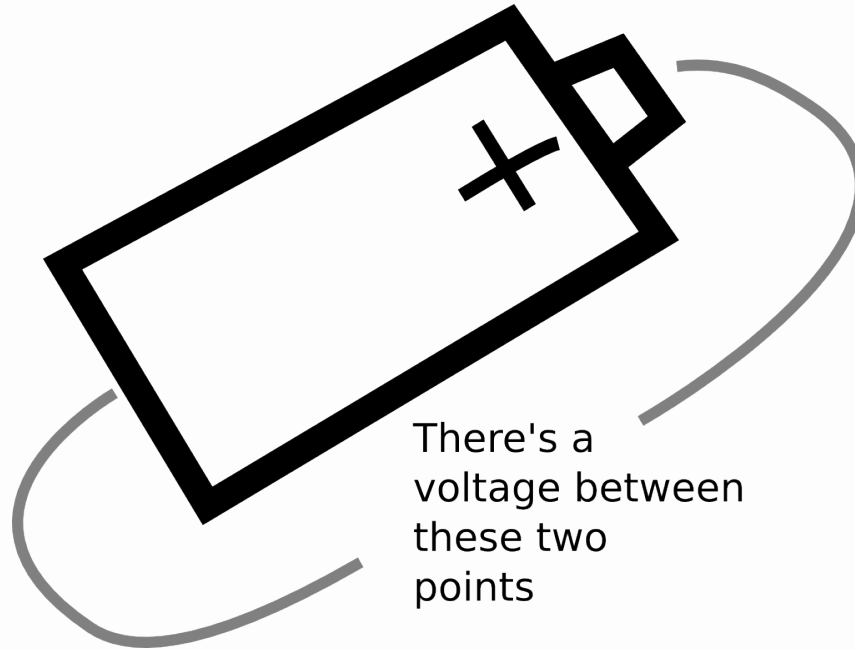

Load

- Load is a resistance (measured in Ohms or “R”) you put between a voltage to make current flow

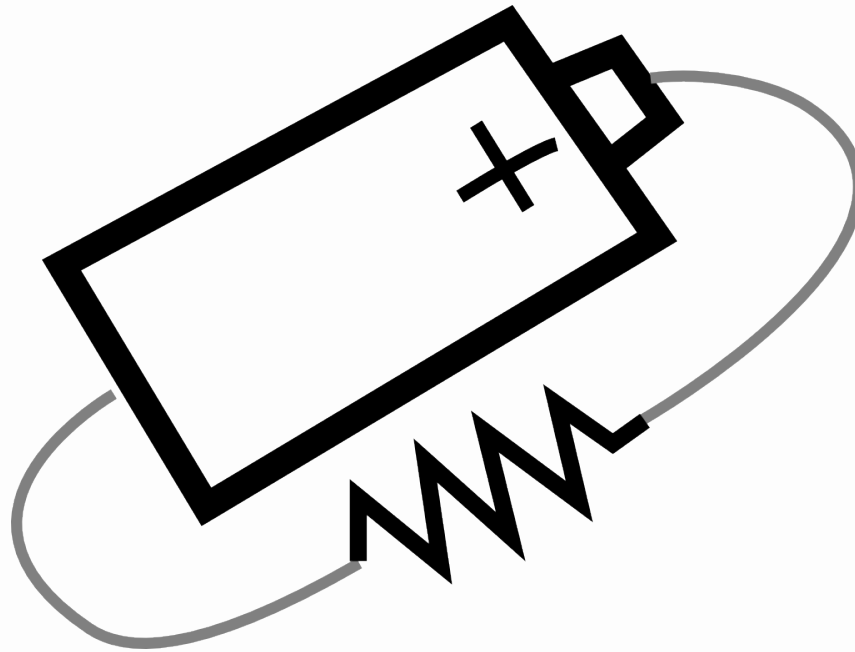

Current

- Current is a measure (in Ampere or A) of how much charge is moving through the circuit.

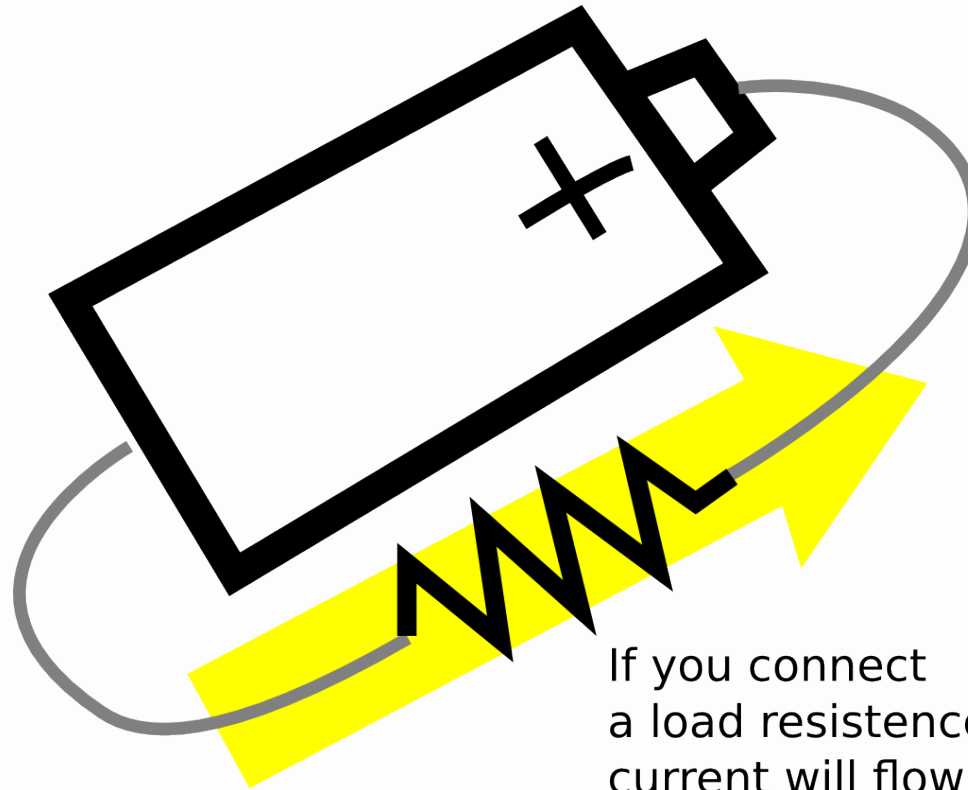

If you connect
a load resistance,
current will flow

Power

- Power is the **voltage multiplied by the current** and is measured in Watts (W)
 - Even at low voltages a lot of power can be used if a lot of current is flowing
 - At high voltages, very little current needs to flow to use a lot of power
- Power is unique because it's the only way you can compare currents at different voltages

Some identities

- $I = V / R_{(\text{load})}$
 - Into the same load, higher V makes more current flow
 - At the same voltage, higher load resistance makes less current flow
- $P = I \times V$
 - Lower V or I , less power
- $P = V/R \times V = V^2/R$
 - **Half voltage --> quarter power!**

Power is boss

- To talk about power, talking about voltage or current alone is useless
- $P = IV$ so we need to talk about current AND voltage if we talk about either
 - Eg, “it takes 50mA”... 50mA at 1.2V == 60mW, 50mA at 5V == 250mW... which is it?
- Converting voltage and current measurements to power lets you compare measurements made at different voltages

However...

- If the voltage part of your measurement is constant, you can treat current part as a stand-in for being a scaled version of power
 - Shortcut is true if you are interested in relative changes in power local to same measured rail

Arm Energy Probe Basics

- What it is
- Quick electronics 101 recap
- Measuring around regulators
- Wiring your board for AEP usage
- Some actual measurements
- Major sources of measurement error
- Linux Commandline tool

Regulator structure

- Regulators adapt a voltage source to provide a different voltage, even if the load is changing dynamically

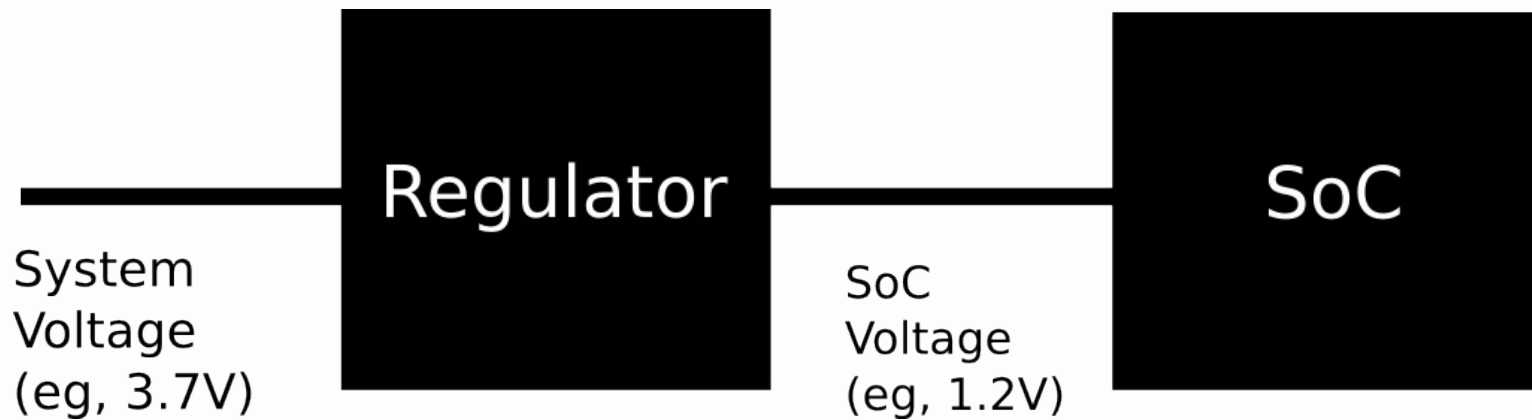

Traditional current measurement

- Normally we would stick an ammeter in series with the load

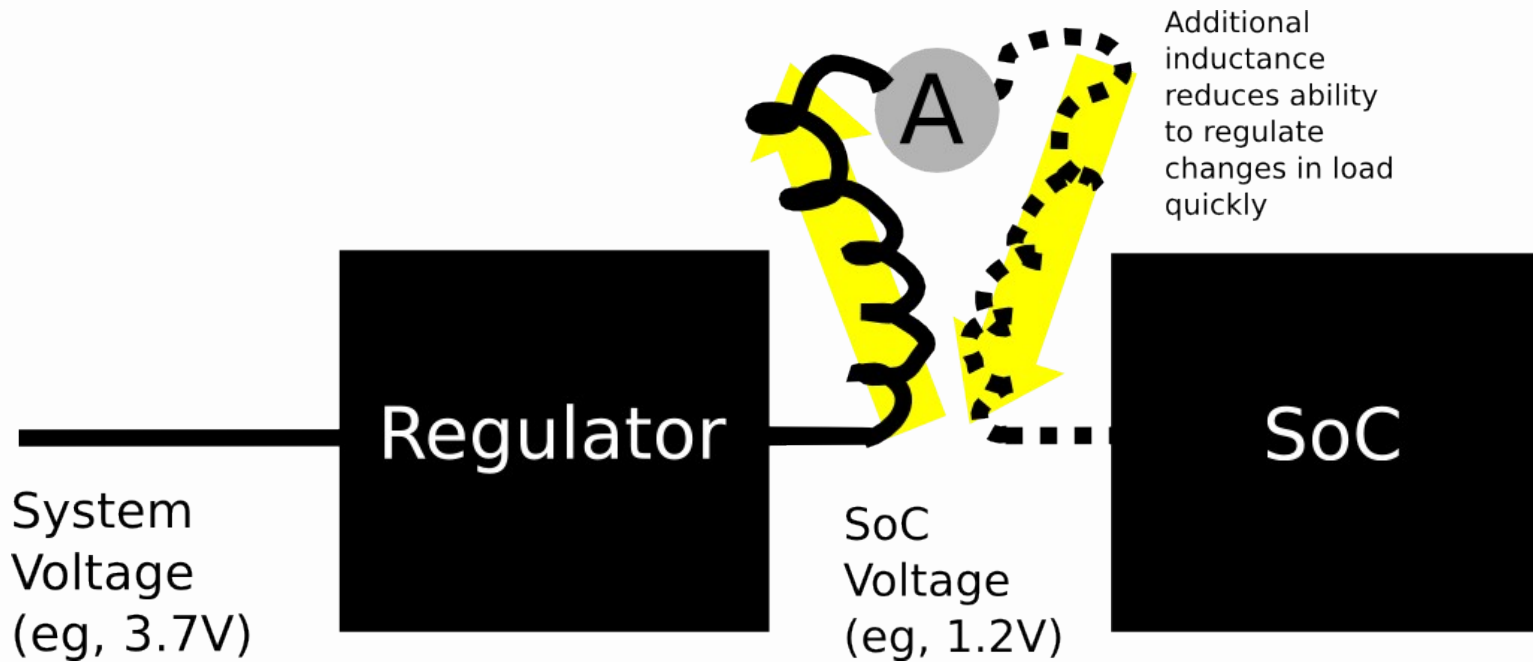

Traditional current measurement

- Regulator cannot “see” a fast-changing load clearly and fails to regulate

– Cpu crash

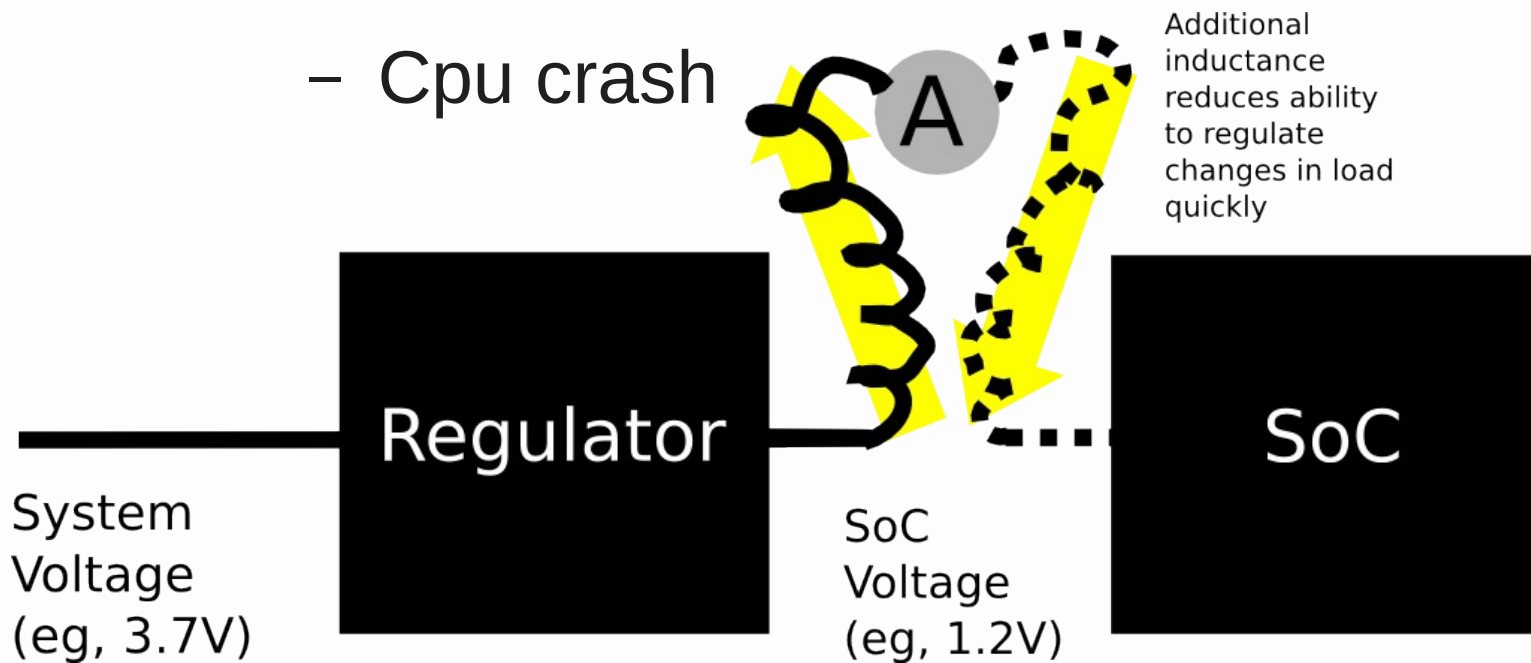

Shunt current measurement

- A shunt is a very small resistance (typ 33mR) placed in series with the load right on the PCB

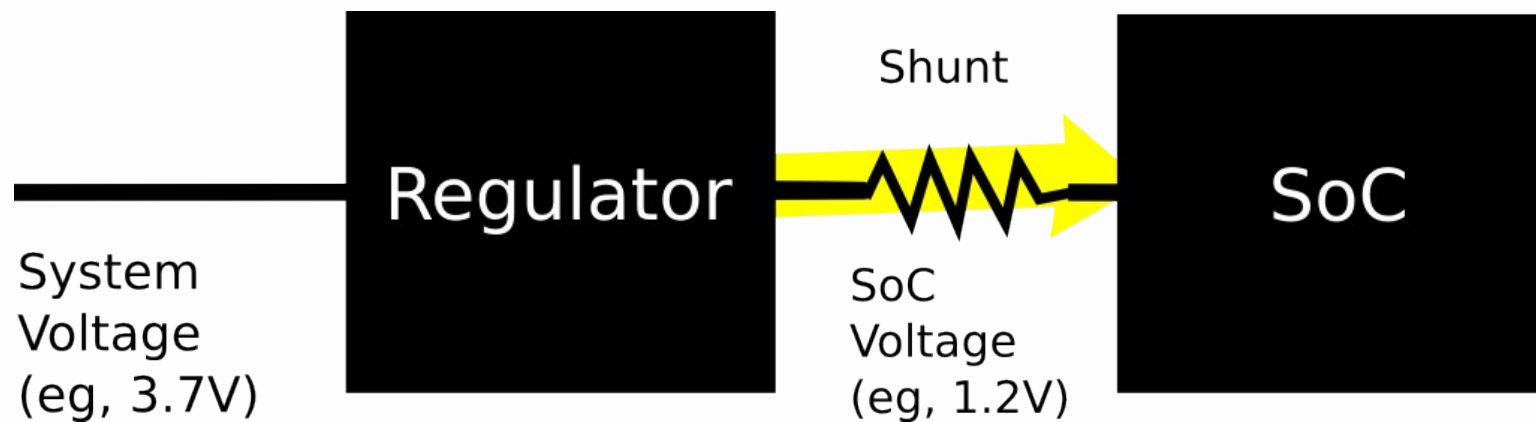

Shunt current measurement

- It introduces a very small reduction in voltage in proportion to current flowing

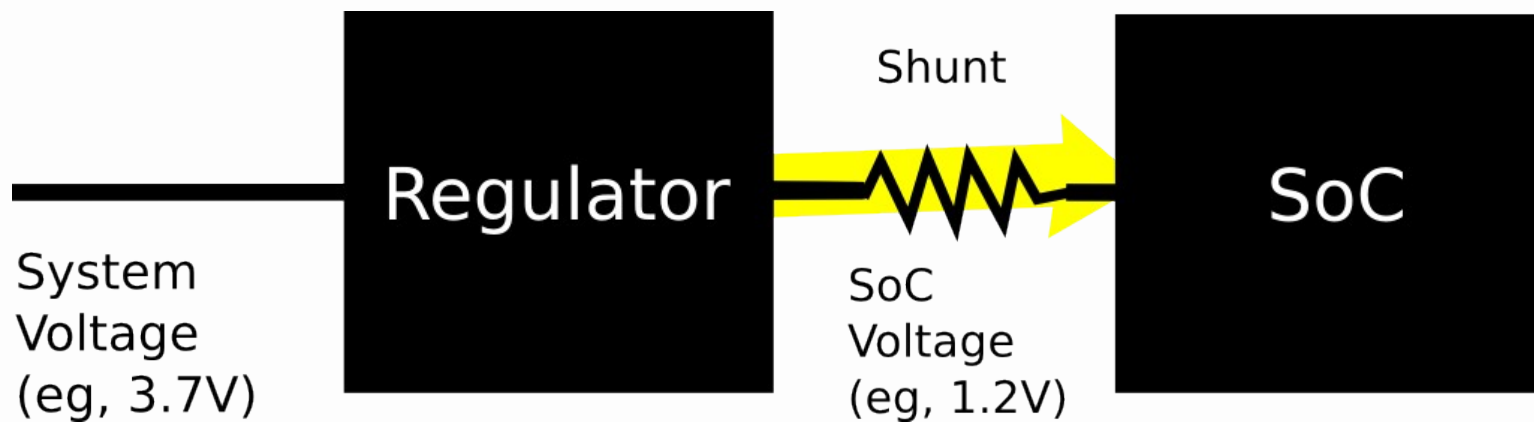

Shunt current measurement

- The energy probe adds an amplified voltmeter to measure the tiny voltage drop across the shunt

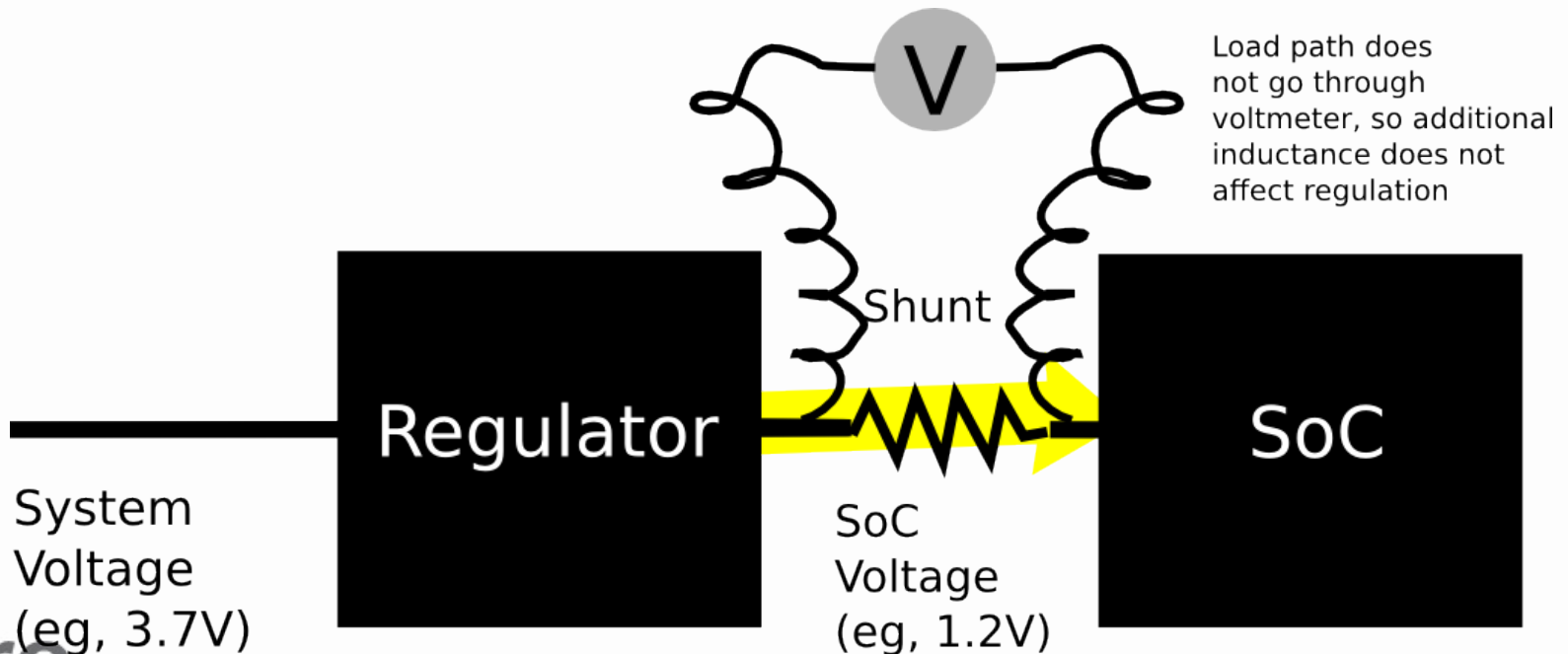

Shunt current measurement

- Because the shunt is a small resistor or metal staple, the regulator can usually “see through it”

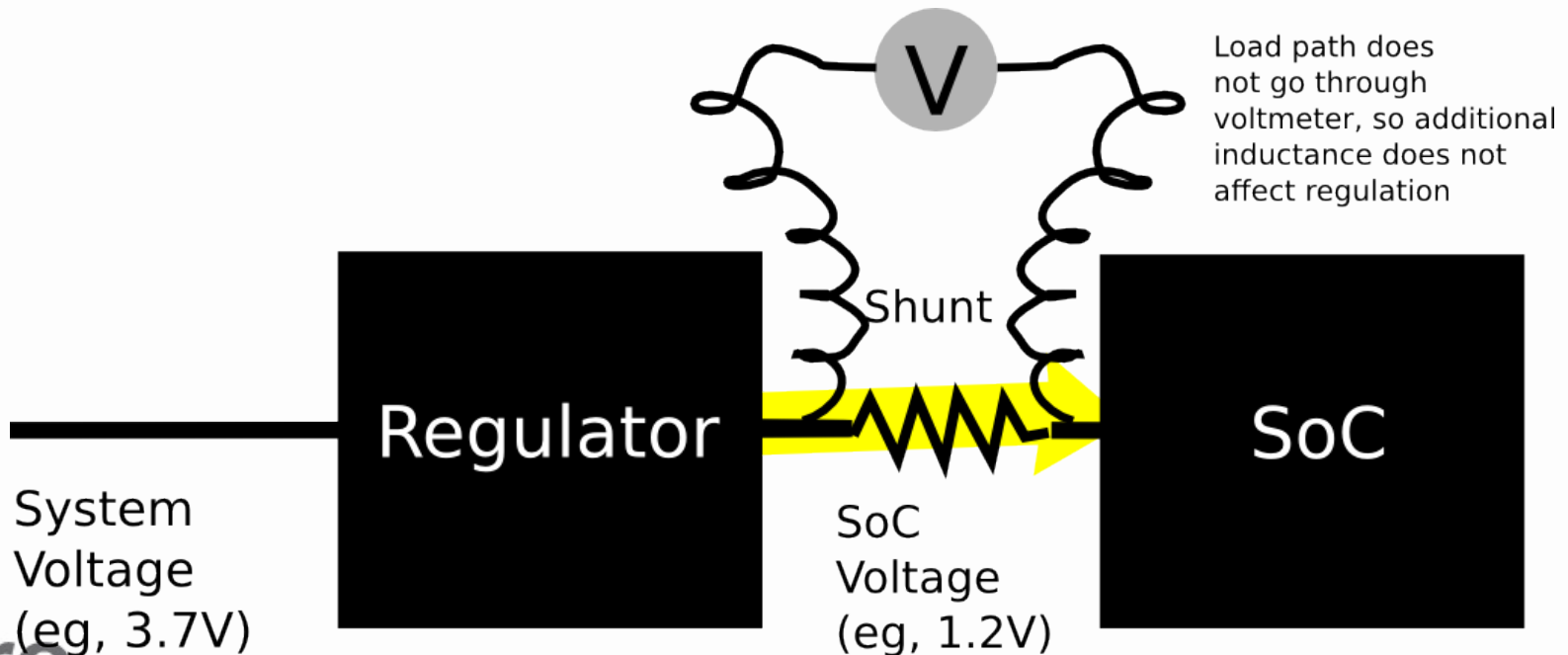

Shunt current measurement

- Some regulators are only barely stable. You can measure the input side in those cases
 - Your measurement includes regulator efficiency losses

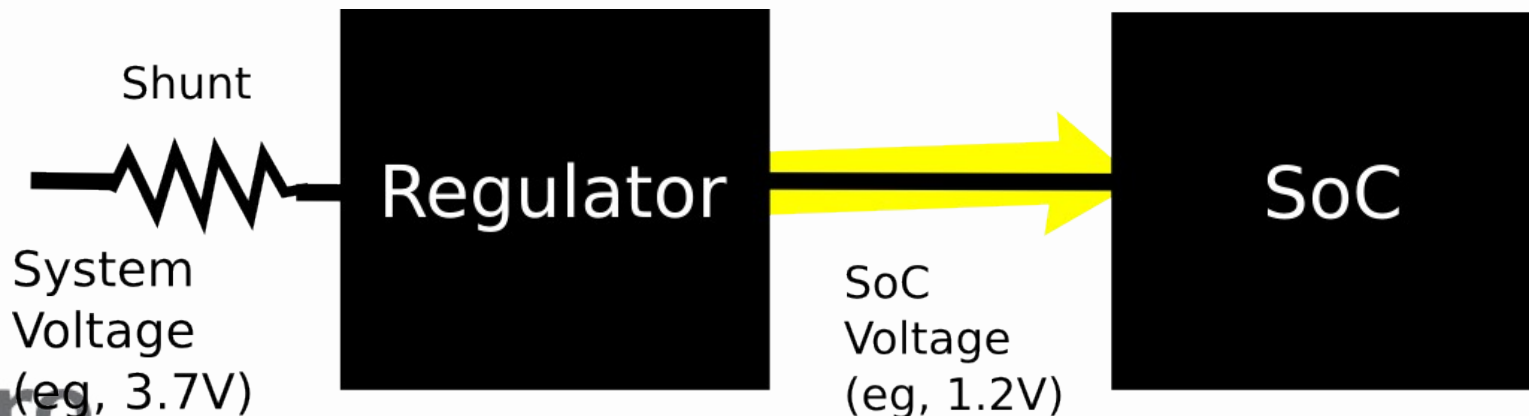

ARM Energy Probe

- So the probe measures and reports **two voltages** on each channel
 - The voltage at one side of the shunt compared to 0V
 - An amplified version of the tiny voltage **across** the shunt

ARM Energy Probe

- If we know the shunt resistance, $I = V_{(shunt)} / R_{(shunt)}$ tells us current flowing
 - Probe cannot deduce current without knowing $R_{(shunt)}$
- Since the probe also measures the shunt voltage compared to 0V, we can calculate **power** from $P=IV$

Arm Energy Probe Basics

- What it is
- Quick electronics 101 recap
- Measuring around regulators
- **Wiring your board for AEP usage**
- Some actual measurements
- Major sources of measurement error
- Linux Commandline tool

Wiring the probe

- You'll need a 7-pin 0.1" header to plug the probe on so you can detach it

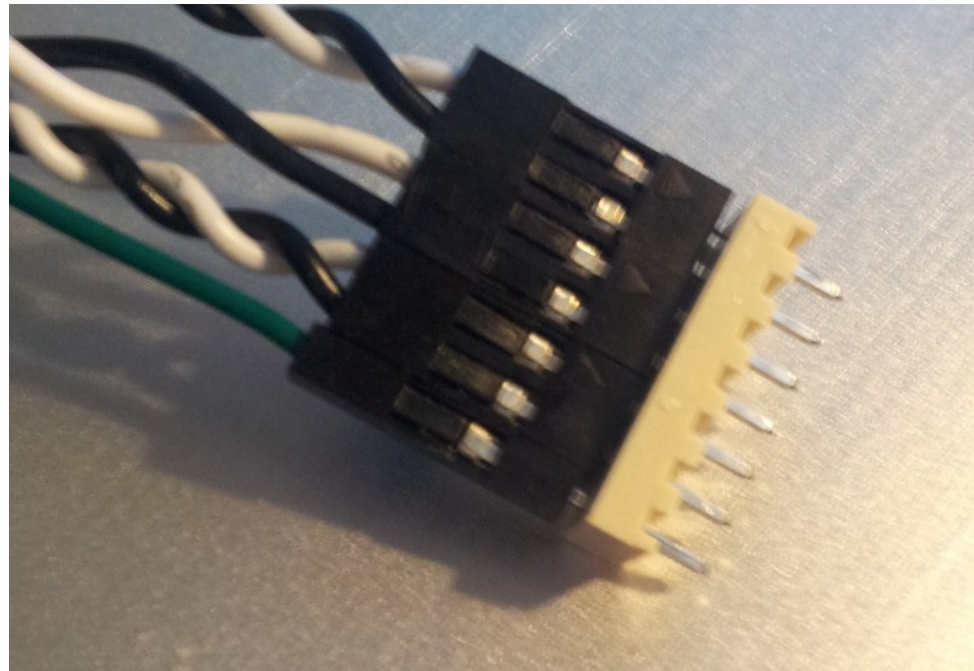

Wiring the probe

- Wire the green 0V lead to 0V on the PCB ideally near the regulators of interest
- Your board will work fine without the probe connected since current will flow through the shunt as usual

Choosing where to place shunt

- Most regulators have no convenient way to place shunt in series with output
- However there is almost always a convenient series inductor at the **input** designed to limit EMI going back up the power supply cable...

Choosing where to place shunt

- We can replace this inductor with the shunt

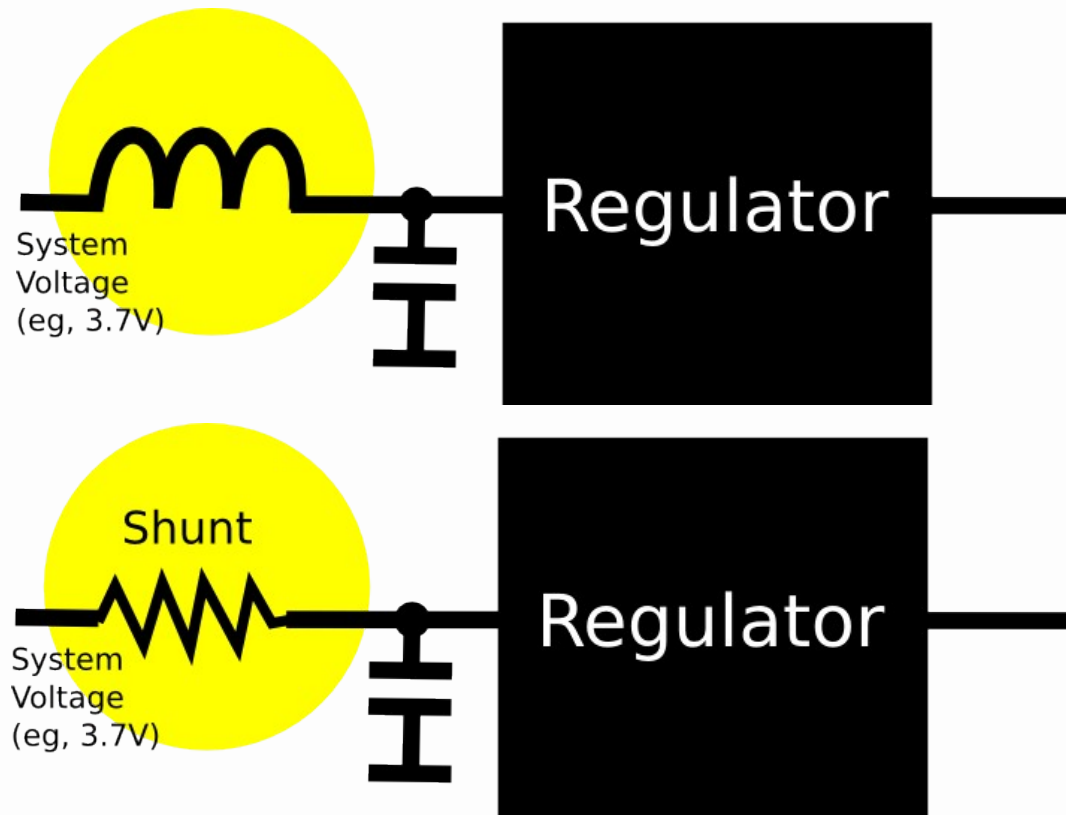

Choosing where to place shunt

- Measuring from regulator input side is fine but
 - You measure the input voltage, not the output
 - You cannot see regulator output DVFS voltage directly
 - Regulator efficiency overhead also measured
 - All real designs must include real regulators, so it's sane

Placing the shunt

- This is a metal precision shunt replacing L22 on 4460 Panda (VDDCORE)

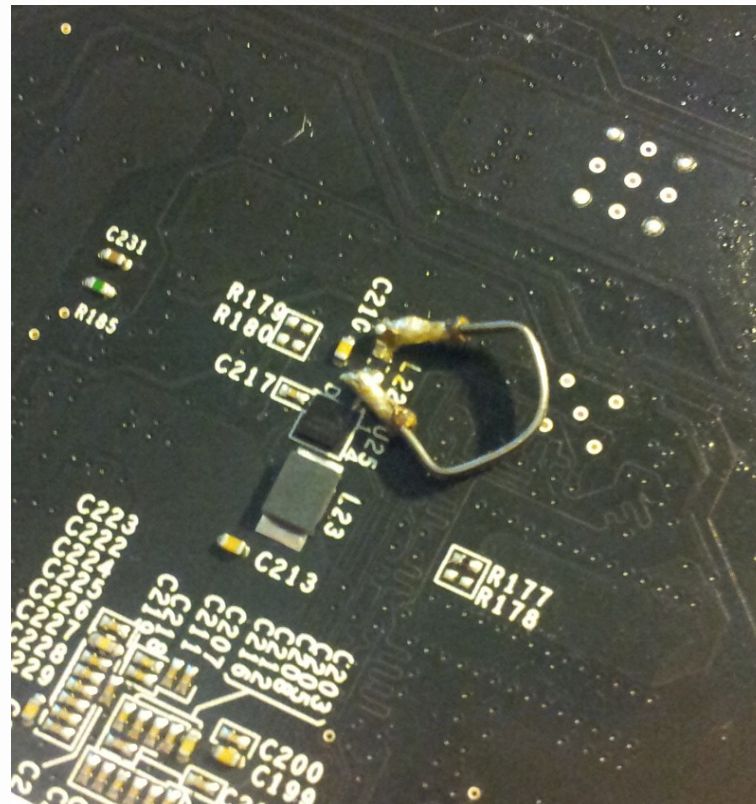

Wiring the shunt

- Twist two thin insulated wires together to wire the two sides of the shunt to the probe connector

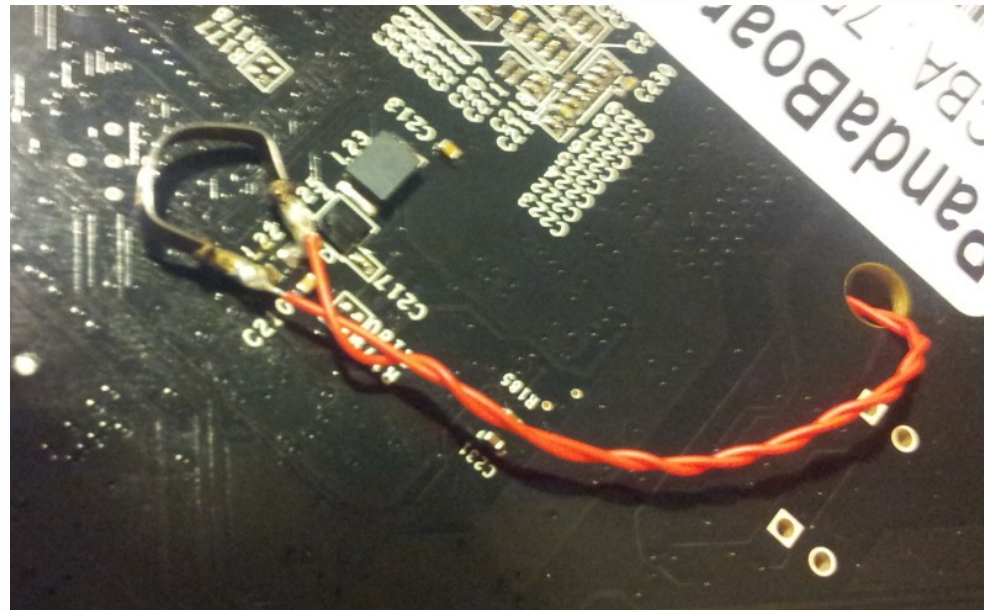

Choosing where to place shunt

- Glue the header to one edge of the PCB

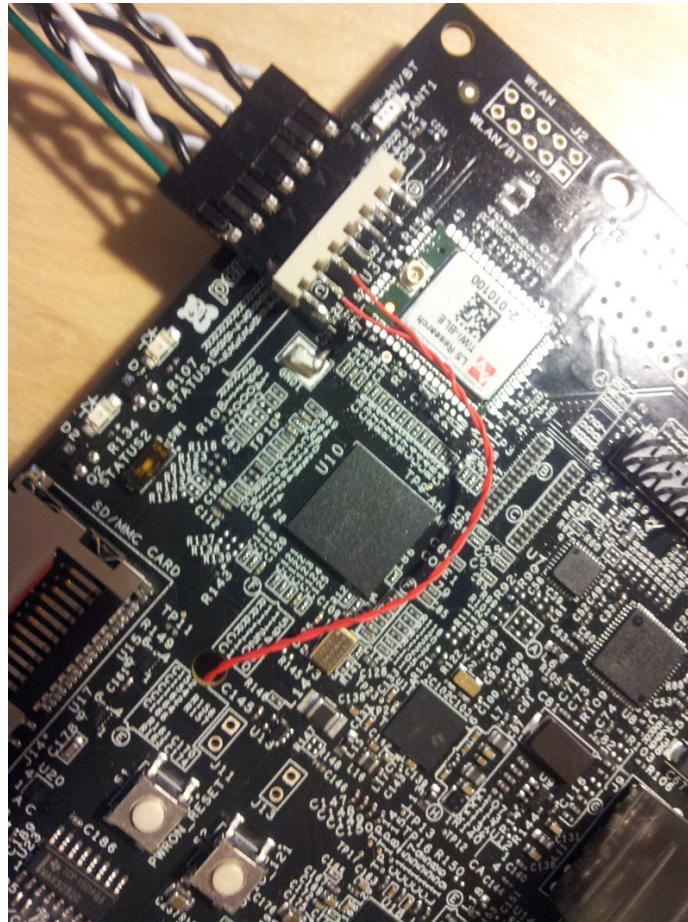

Probe cares about sense leads

- The white side of the sense leads needs to go on the pre-shunt side of the shunt, black to post-shunt
- It won't damage the probe to get it wrong but current readings will always be near zero

Shunt resistance selection

- Low resistance shunt is preferable to minimize regulation disruption
- Probe ADC resolution can be a problem then
 - With 33mR shunt, one ADC count == 4mA resolution
 - Considerable “noise” or aliasing

Arm Energy Probe Basics

- What it is
- Quick electronics 101 recap
- Measuring around regulators
- Wiring your board for AEP usage
- **Some actual measurements**
- Major sources of measurement error
- Linux Commandline tool

Real measurement

- 4460 Panda VDDCORE
- Input side of regulator
- 33mR and 470mR shunt
- idle at U-Boot prompt
- 600MHz dynamic load
- Corrected for slope error
- Using linux commandline

Unaveraged, 33mR shunt

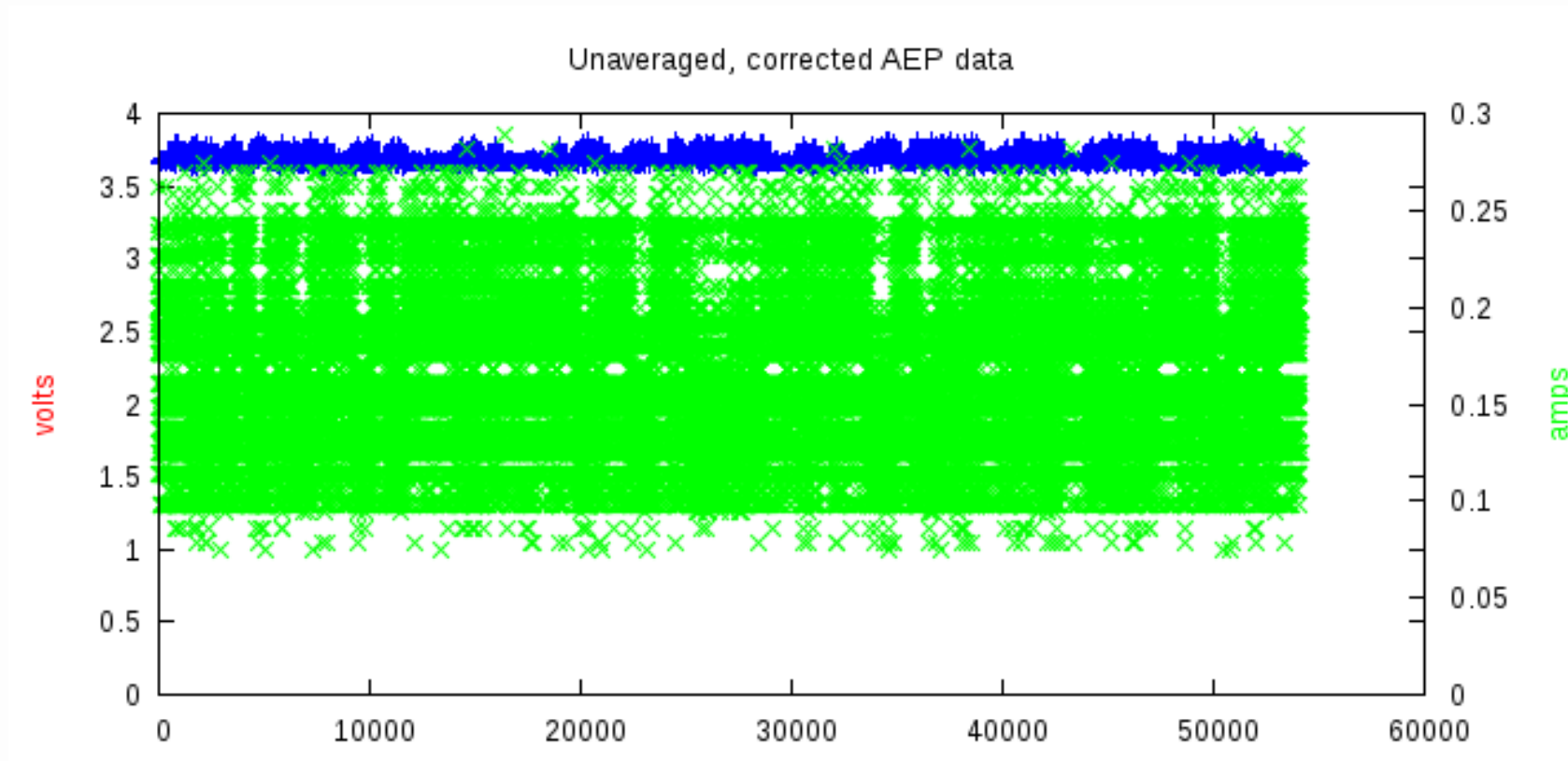

Interpretation

- 33mR is too low resistance shunt for the ARM probe
- limits the ADC count for the measurement to around 5% of ADC range
 - SNR reduced drastically
- Change to a higher resistance shunt so we have a bigger voltage to measure

Same tests with 470mR shunt

- “0.5R” resistor

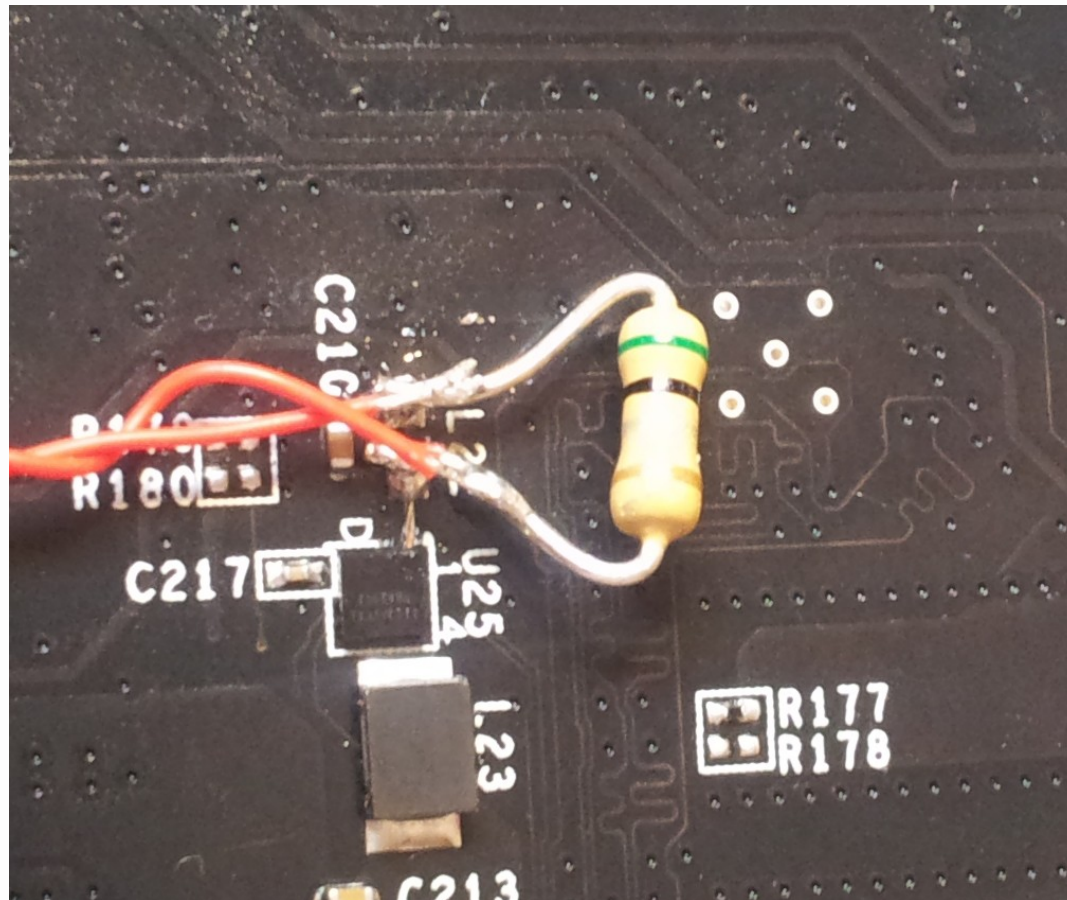

Unaveraged, 470mR shunt

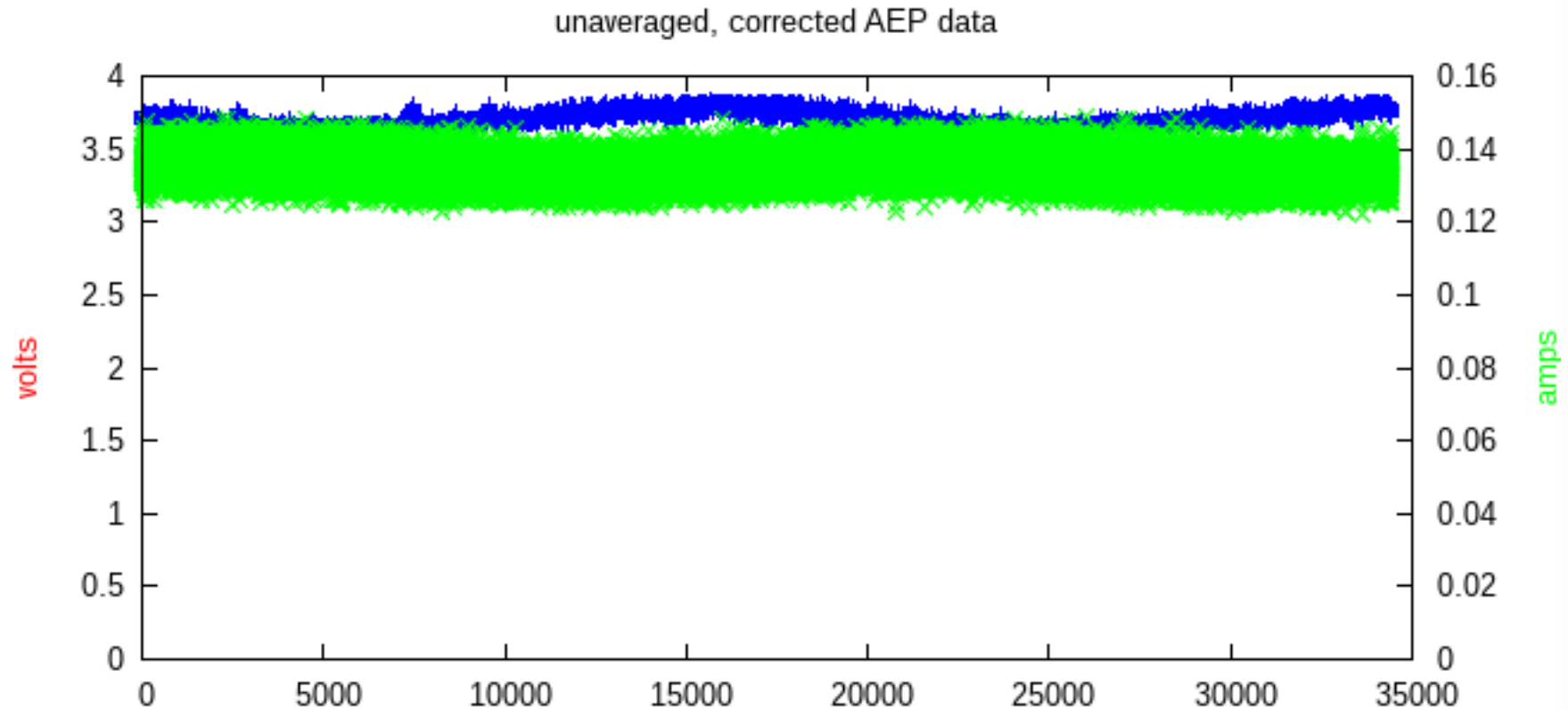

Interpretation

- Much better SNR
- Resolution improved to 280uA / ADC step
 - For static currents, high averaging will give even more precise results

Unaveraged, 470mR Linux

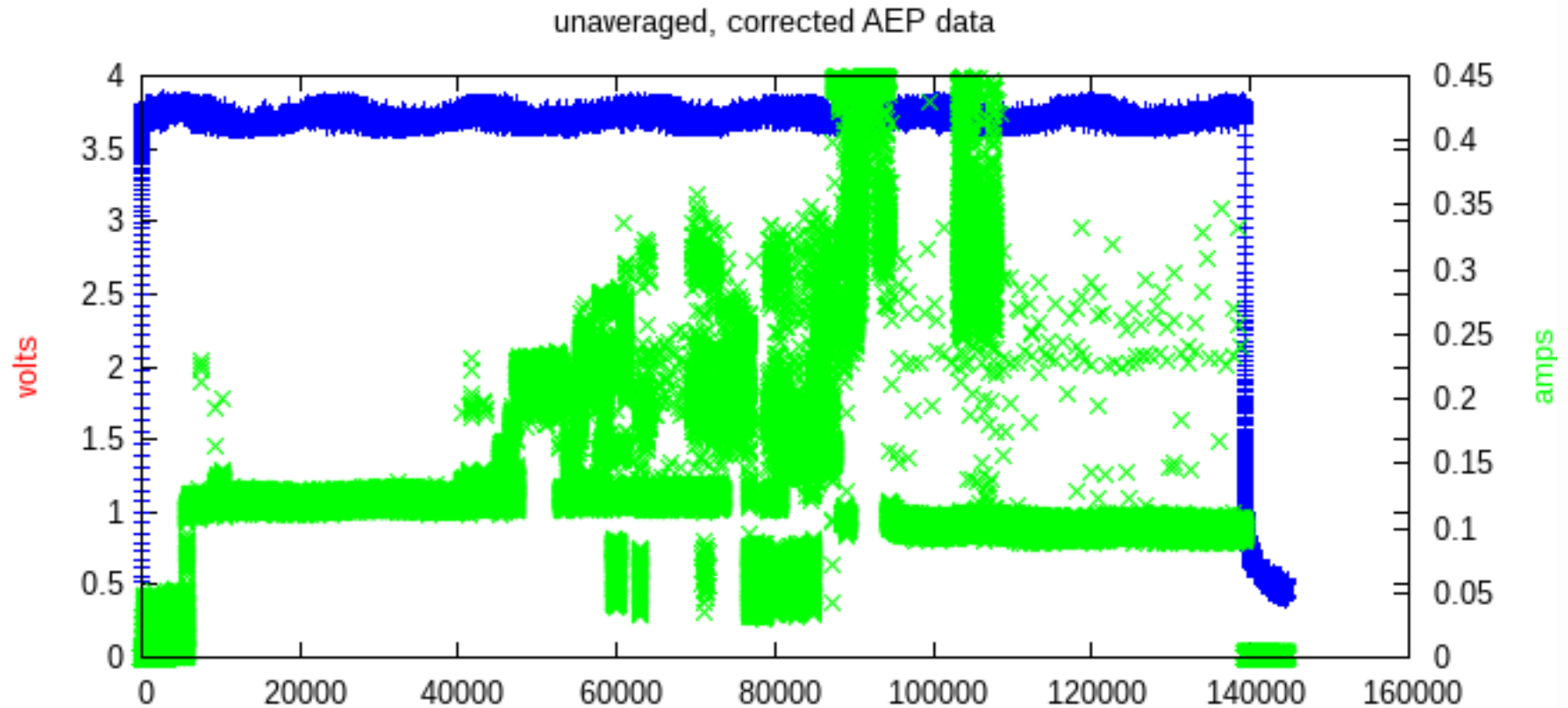

16-pt mean, 470mR Linux

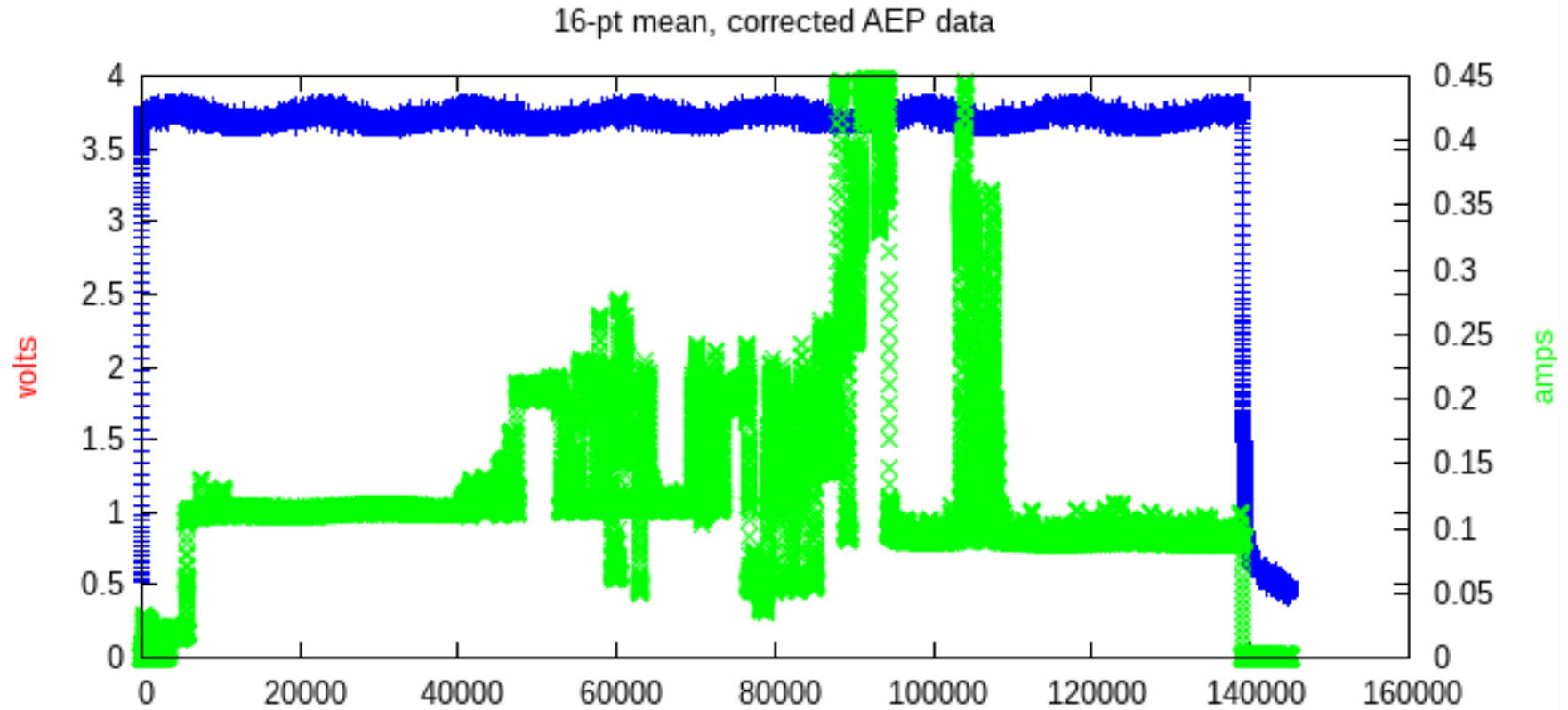

Interpretation

- 100us sample hides spikes
 - Short increases in current may be missed completely
 - Some rails dynamic load changes at 1GHz
 - 1 AEP sample covers 100,000 CPU clocks...
 - Any averaging makes it worse
- Rest of the graphs show power, not separate voltage and current

POWER, unaveraged, 470mR Linux

POWER unaveraged, corrected AEP data

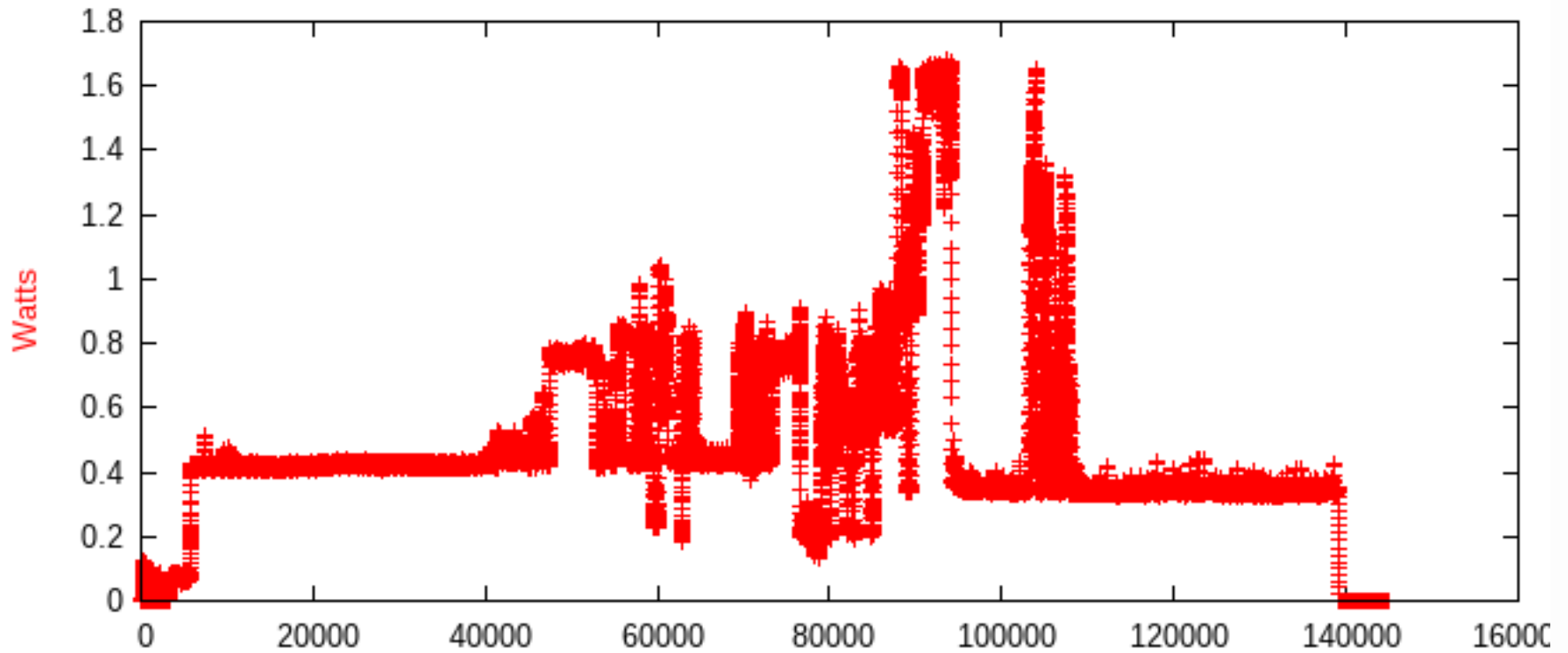

6 channel “cumulative” view

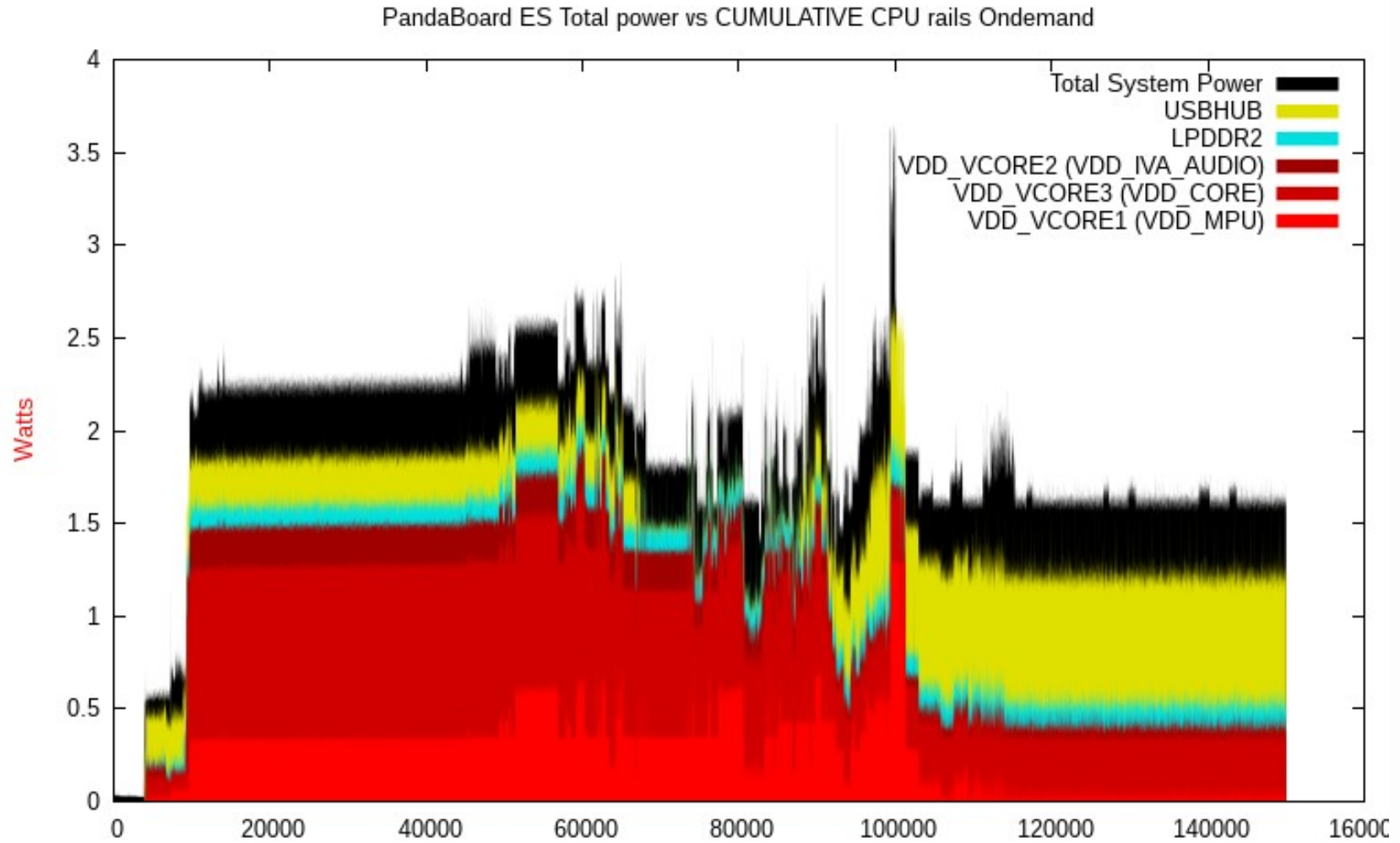

Summary

- ARM probe optimized to measure high currents
- Unable to use small value shunts well with normal currents
- Try 470mR shunt first
- Use 0.1% or 1% tolerance resistor if available

Caution

- Higher resistance shunt == more voltage drop... measured current flows through the voltage drop and $P=IV$ for the shunt
- It has to dissipate the power as heat
- 470mR resistor used here rated 0.25W
- Only good for 0.7A at common voltages
- Higher power resistors available

Various power rating resistors

- 5W, 2W, 1W, 0.5W and 0.25W



Power dropped in shunt

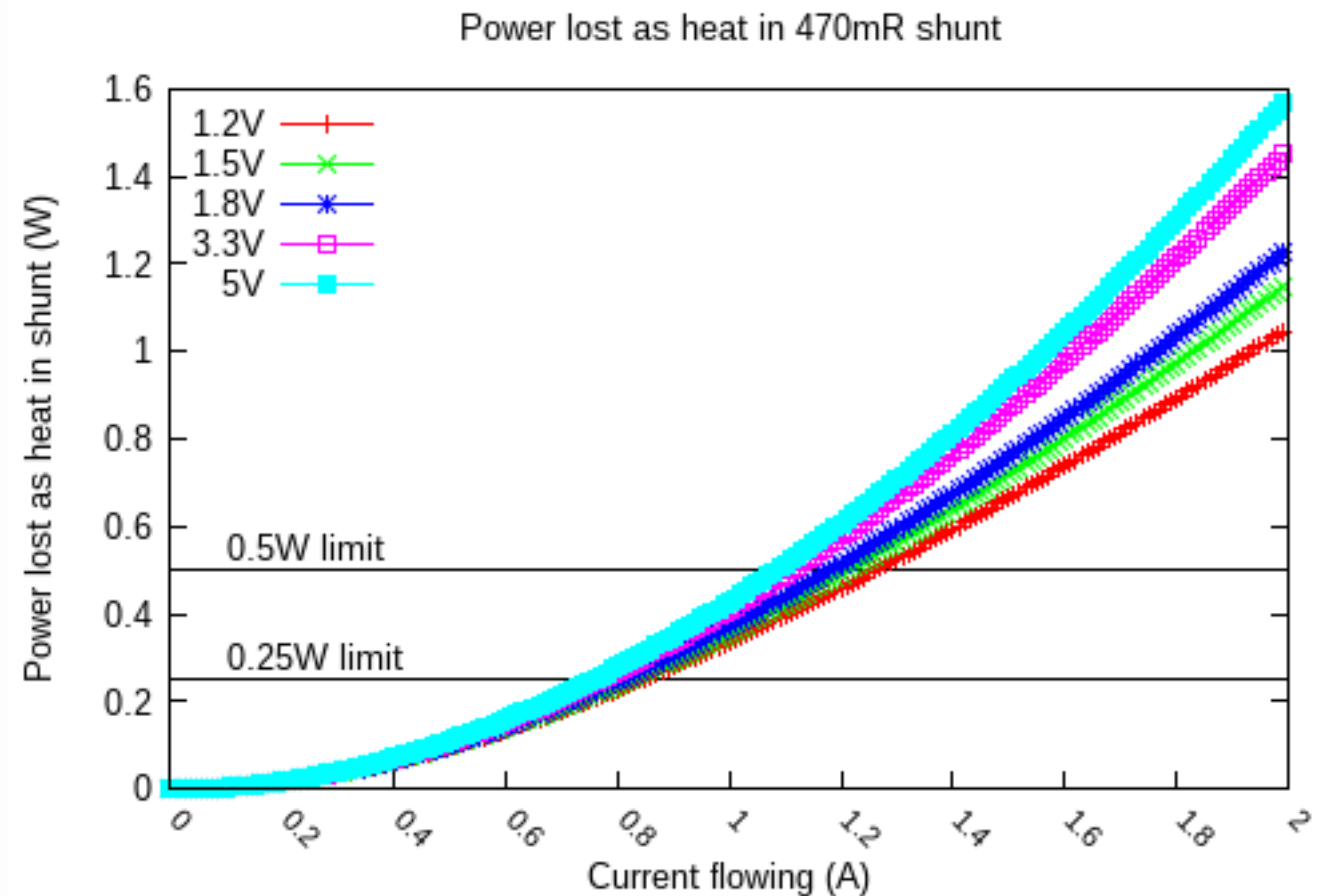

Parallel up shunts to cope

- 2 x 470mR, 0.25W shunts in parallel becomes 235mR, 0.5W capable
- The voltage drop is halved and the dissipation limit doubled (resolution /2...)
- Can cope with ~1.5A at the common voltages

Power dropped in shunt

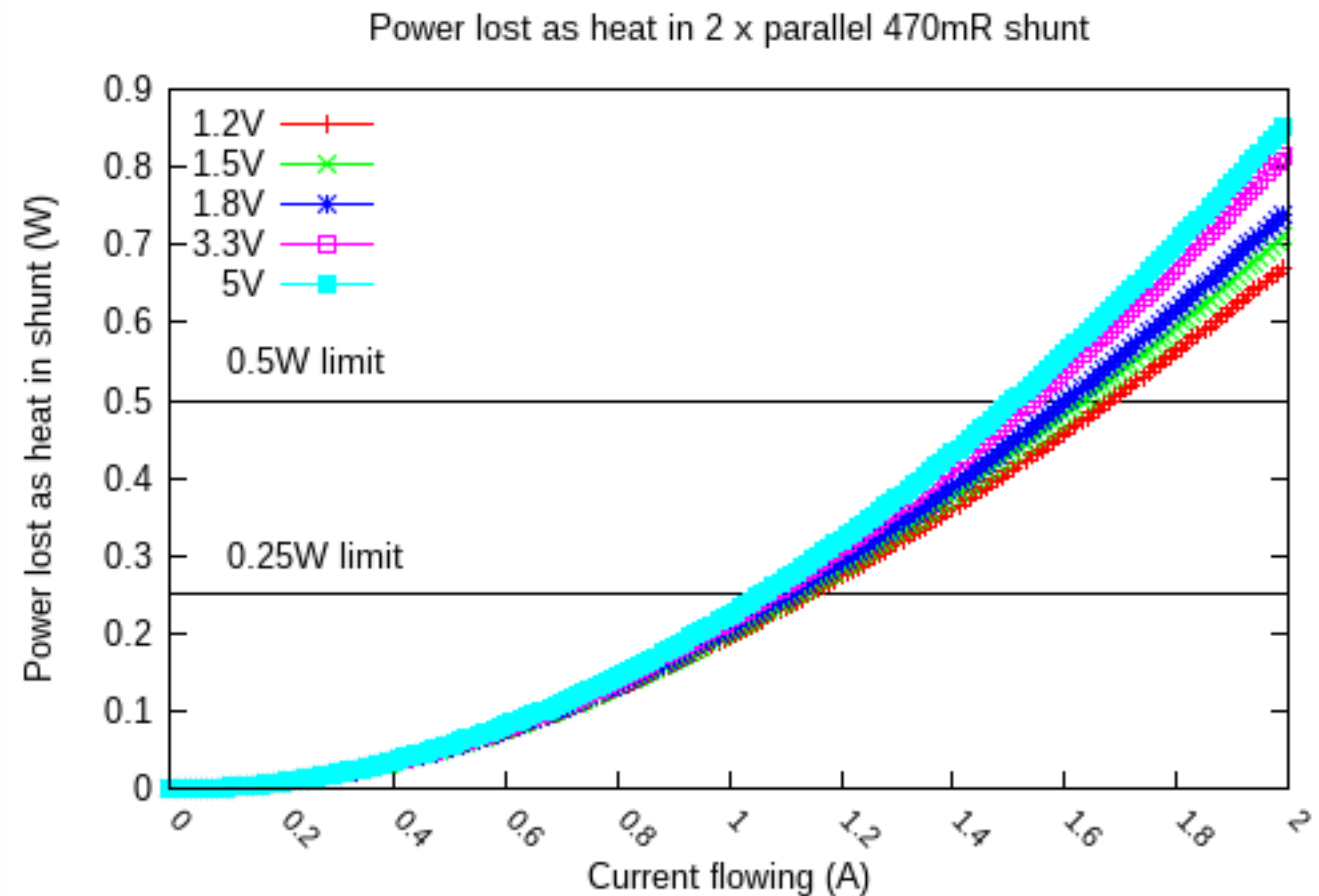

Shunt selection vs current range

- Probe can only measure up to 165mV across the shunt
- It means you have to select the shunt resistance according to the maximum current expected
- Following chart shows effect of common shunt values
 - Lower R_{shunt} --> high noise, low resolution

Shunts dropping max 165mV

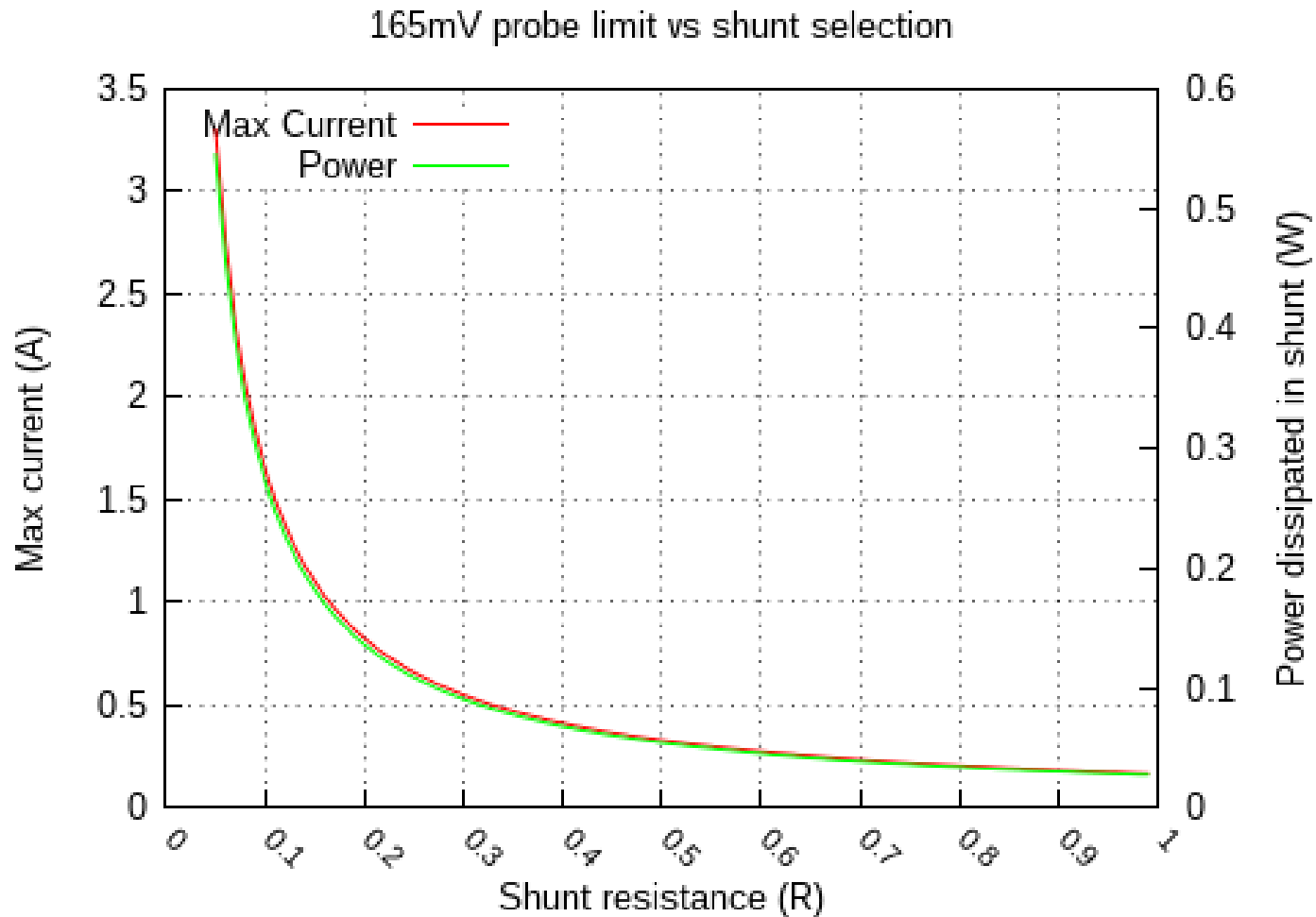

Attaching shunt to DC jack

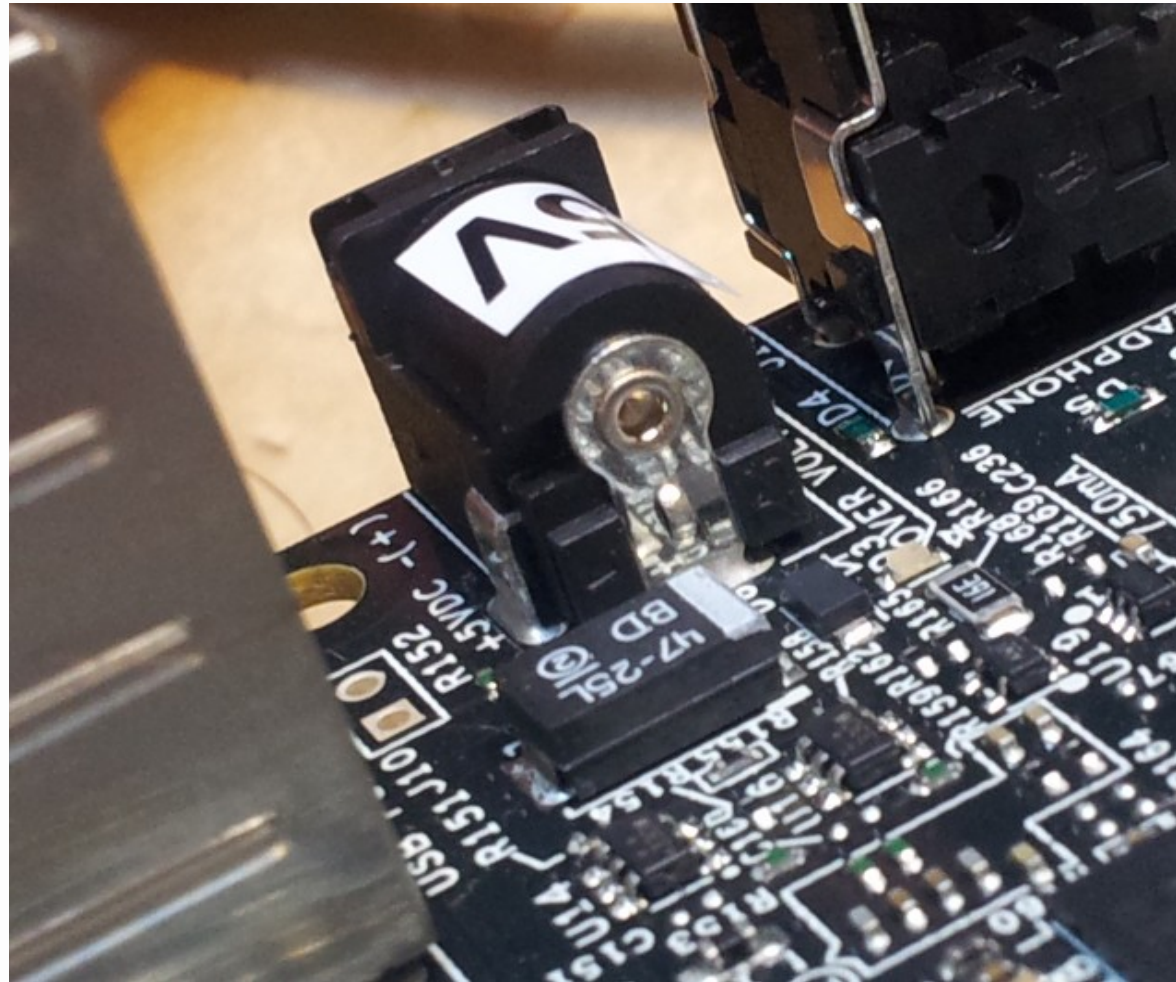

Cut the + conductor



Apply shunts in parallel of power

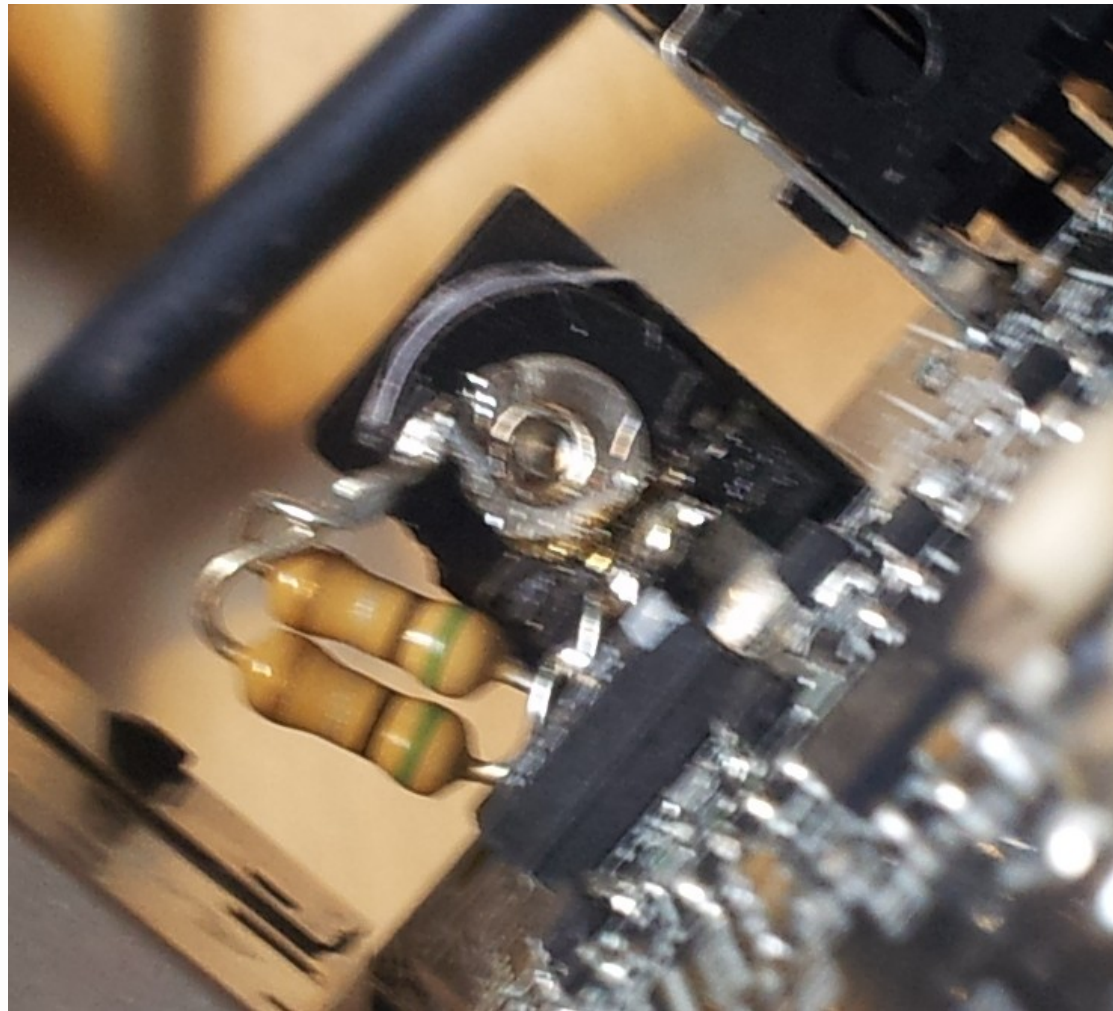

Panda ES wired for 9 rails

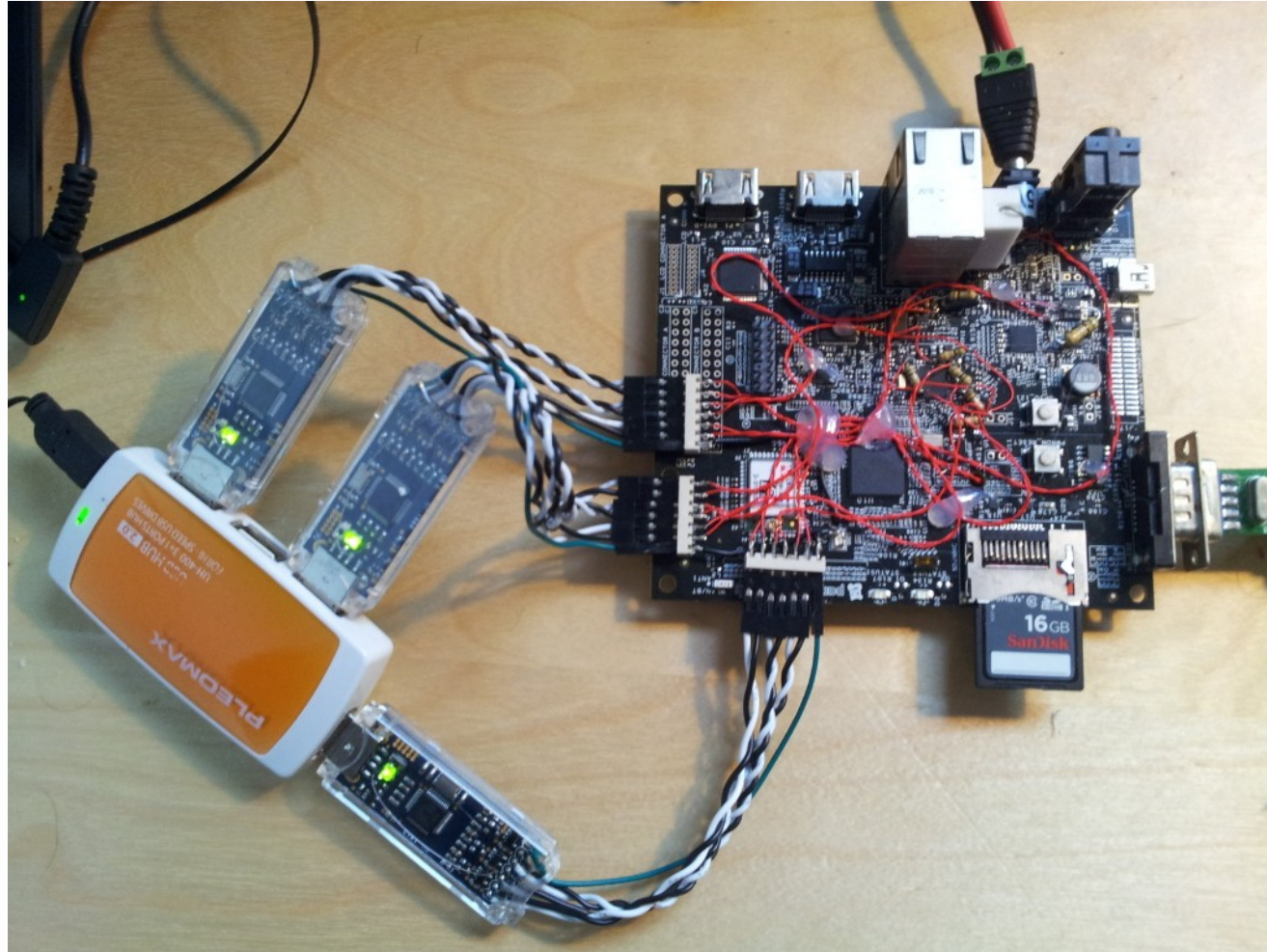

Arm Energy Probe Basics

- What it is
- Quick electronics 101 recap
- Measuring around regulators
- Wiring your board for AEP usage
- Some actual measurements
- Major sources of measurement error
- Linux Commandline tool

Performance characteristics

- Badly nonlinear at low cross-shunt voltages

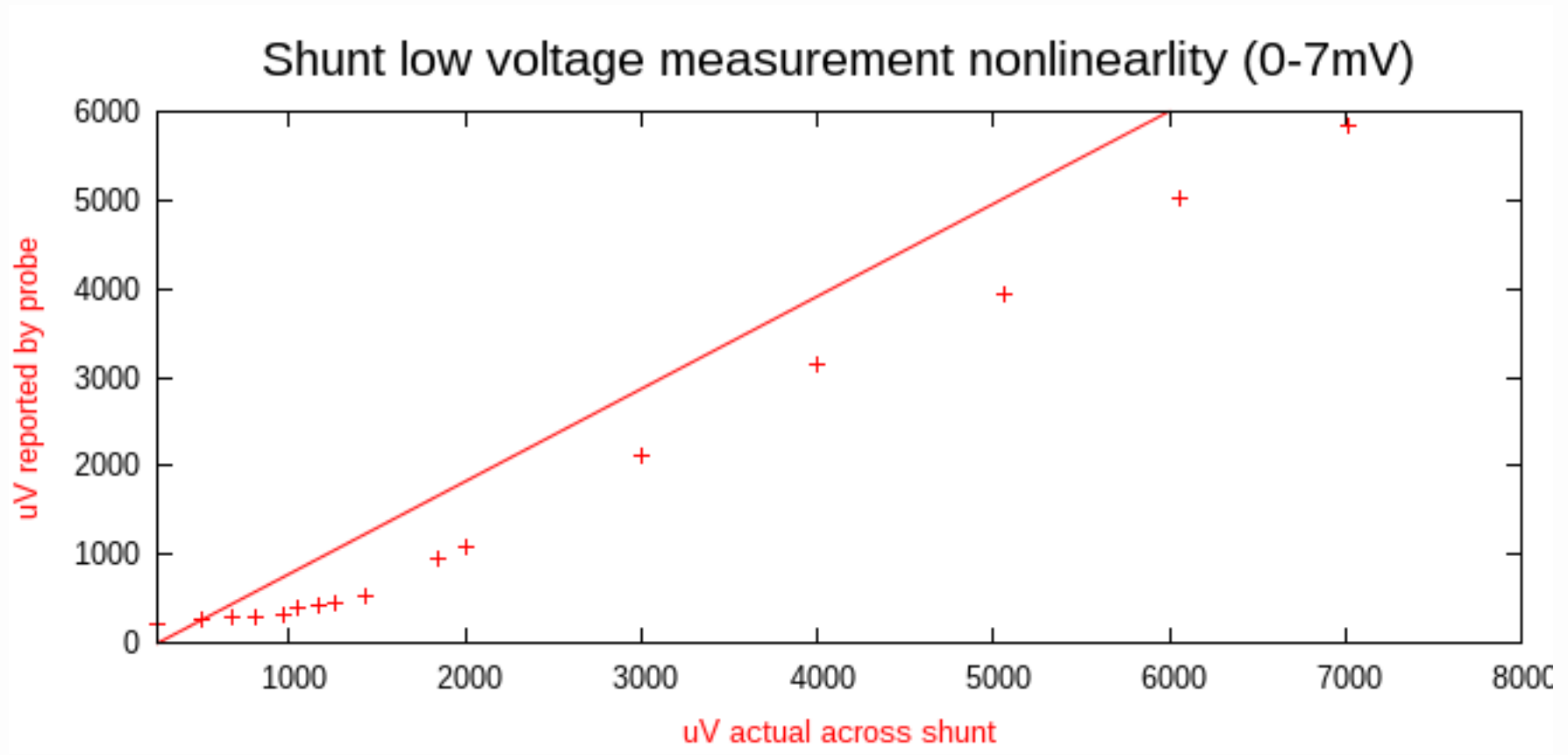

Performance characteristics

- Raw results < 50mA (470mR shunt) **poor**
 - Very nonlinear, other errors mentioned next

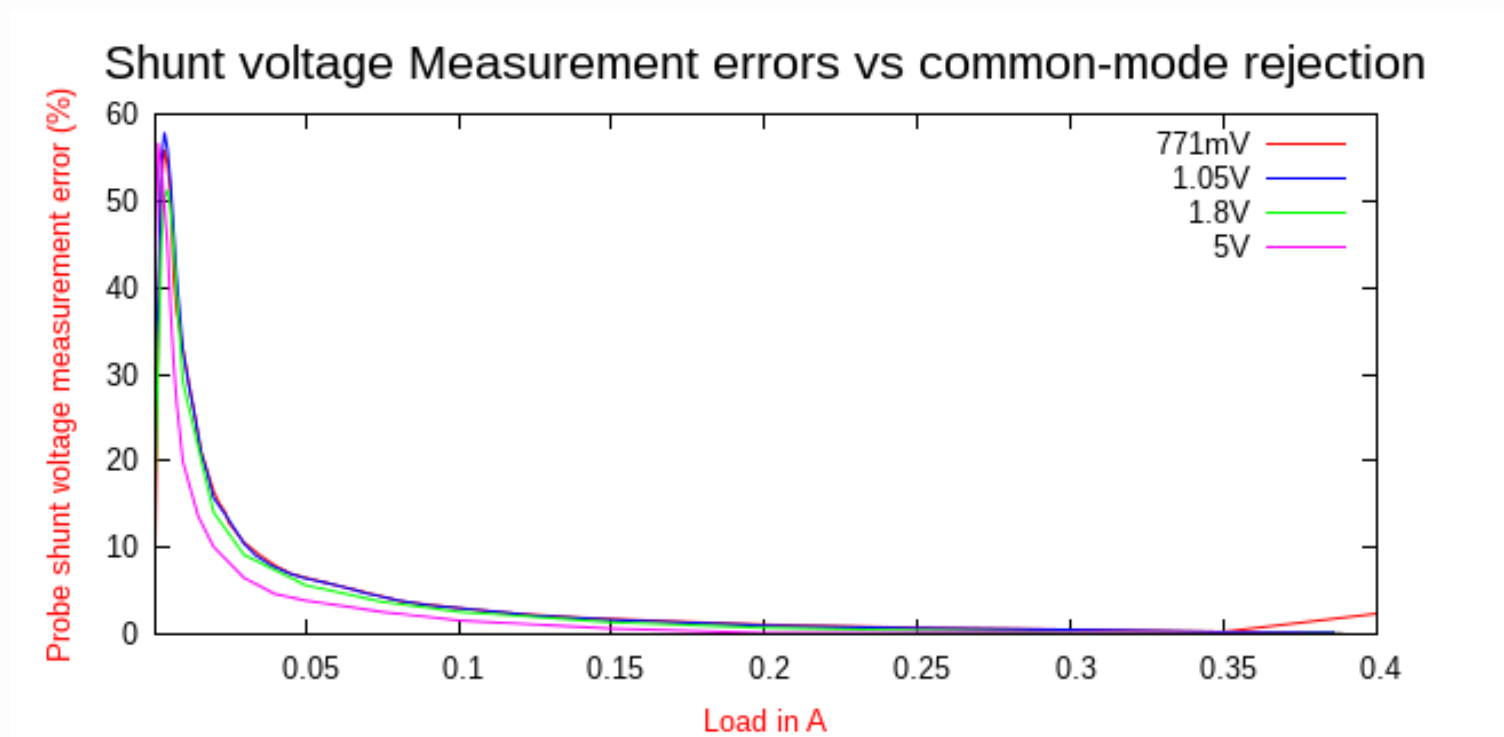

Analysis

- Raw probe current numbers below $\sim 50\text{mA}$ ($470\text{m}\Omega$ shunt) have significant error
 - Interpolation models and autozero mentioned next can reduce this error
- Below 2mV across shunt ($\sim 4\text{mA}$ with $470\text{m}\Omega$ shunt) measurements unrepeatable
 - Due to shape of nonlinearity at low end, only $4\mu\text{V}$ meas. difference between 0mA and 1mA
 - Well below noise and temperature drift floor

Autozero setup

- Short all shunt inputs with wire to 0V
- Use autozero then monitor result over time

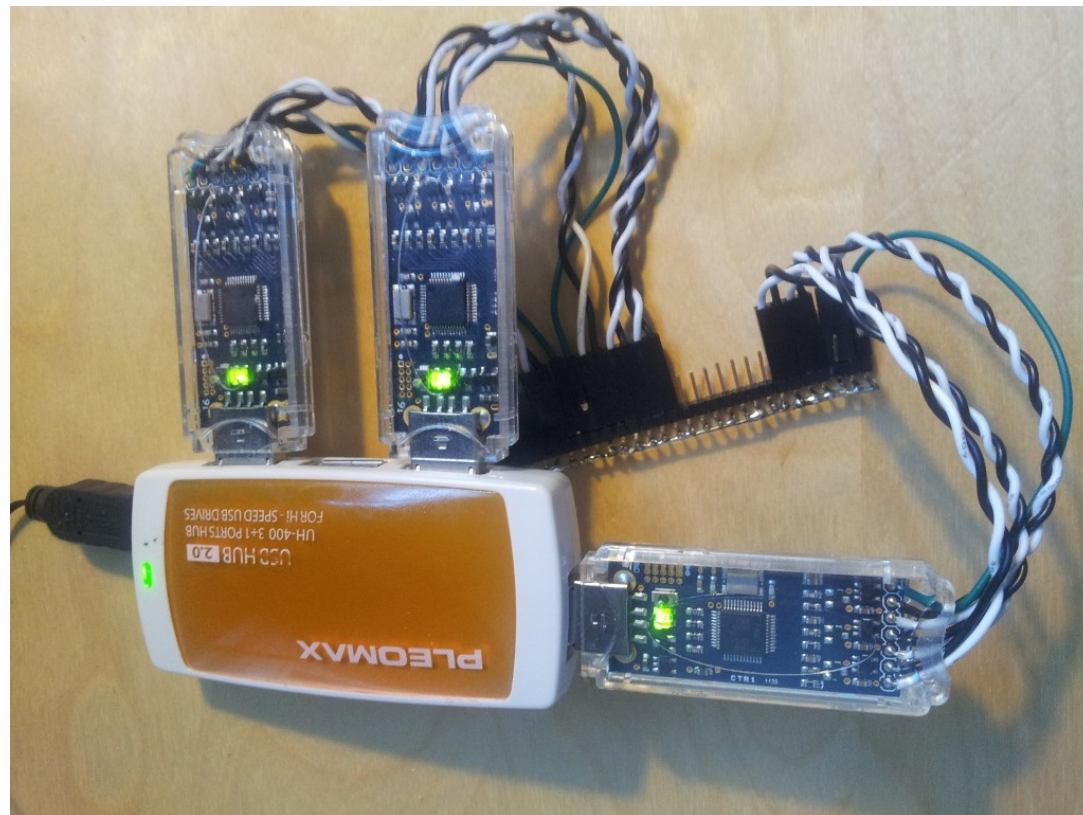

Temperature drift vs 0A current

- +1mV offset from 10°C drop in room temp
 - == “0A” error of +2.1mA with 470mR shunt !

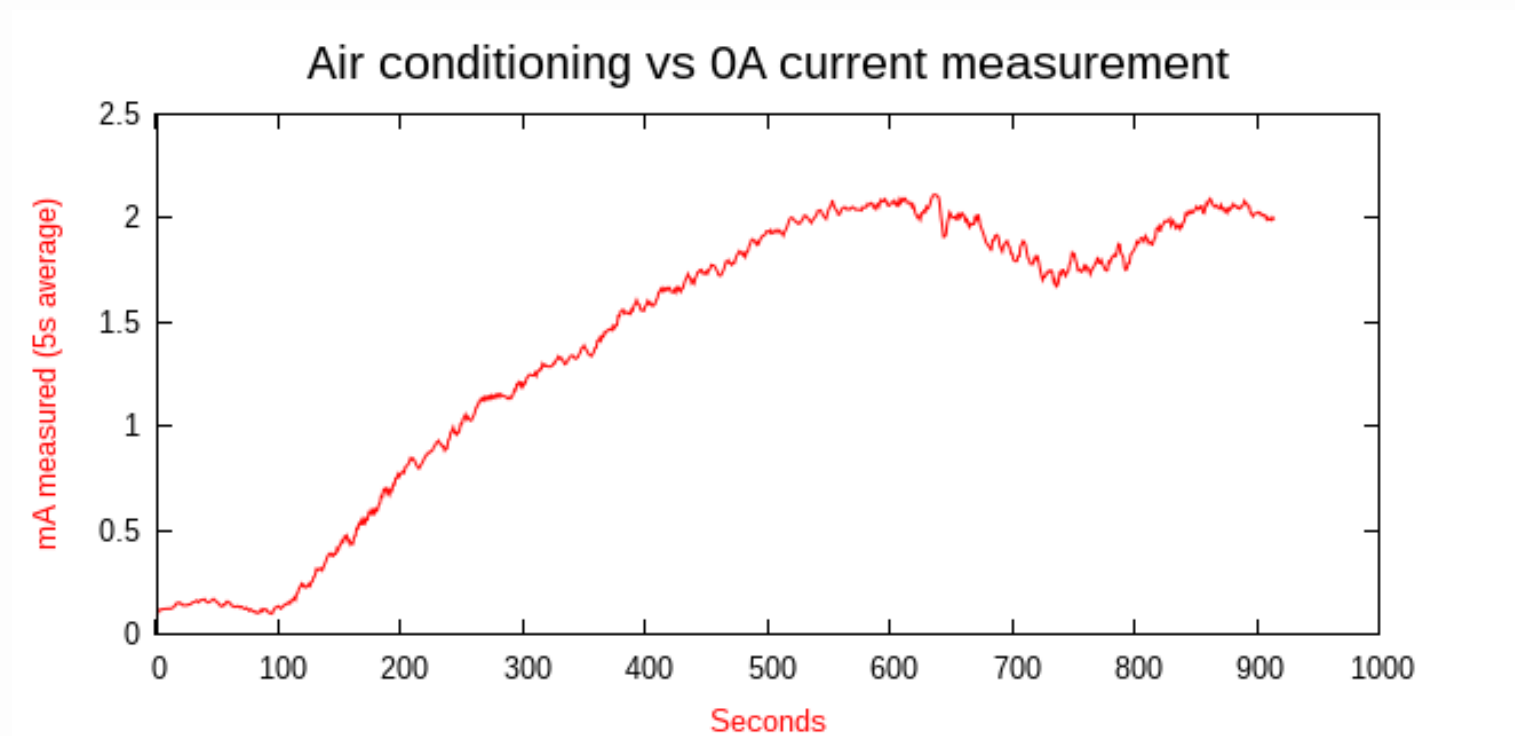

Temperature vs voltage

- Same problem on voltage channel, air conditioning offsets by -15%

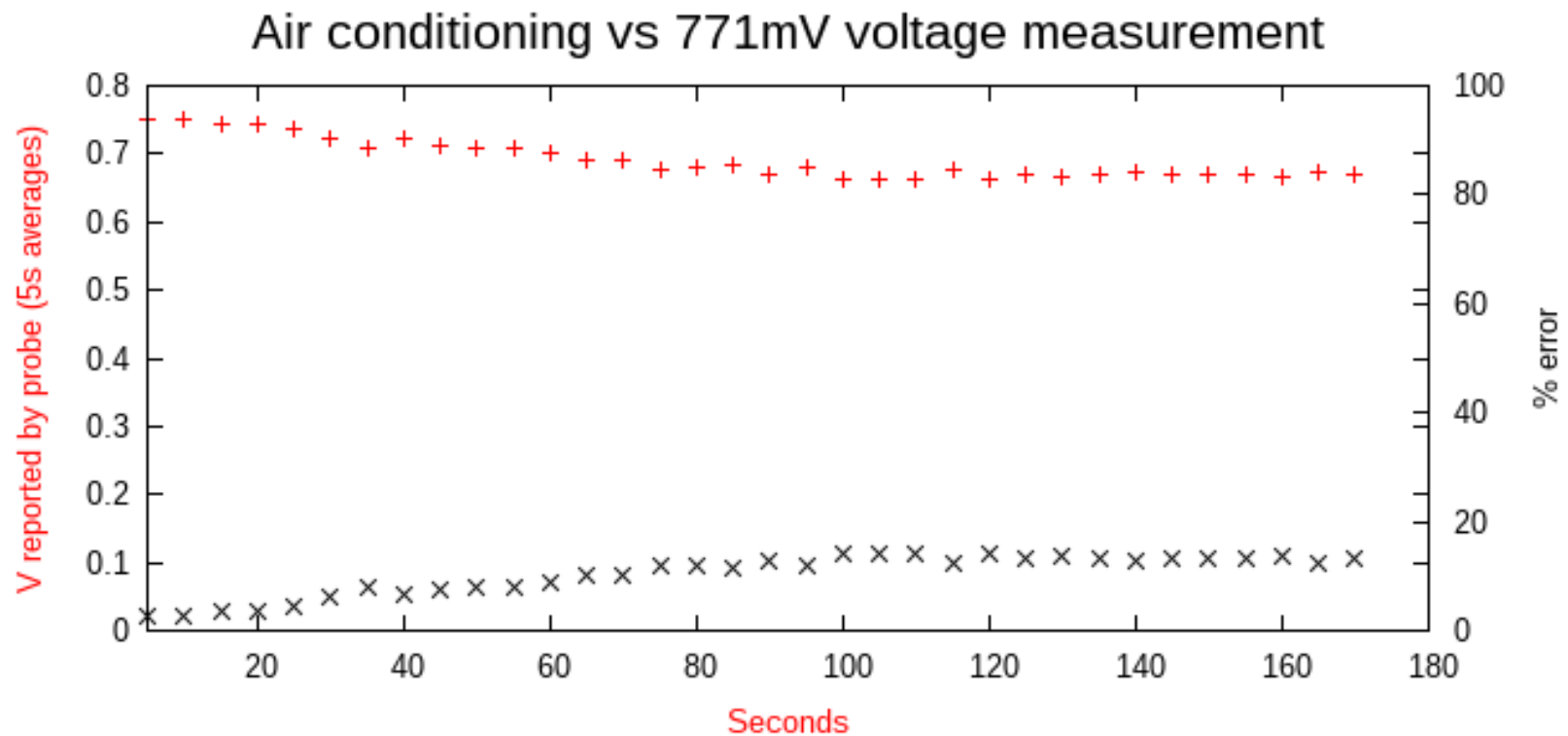

Analysis

- Shunt measurements have $> 1\text{mV}$ ($\Rightarrow >2\text{mA}$ with $470\text{m}\Omega$) offset uncertainty due to temp
- Can combat it a bit by keeping temperature as stable as possible and measuring offset before real measurements (**--autozero**)
- Currents below a few mA are going to give unrepeatable results and have high error, due to probe nonlinearity, air currents, sunlight on probe etc

Common-mode voltage error

- Shunt voltage measurement has extra error from common-mode (vs 0V) voltage at 2-3V
 - Equivalent to 3.2mA error with 470mR shunt

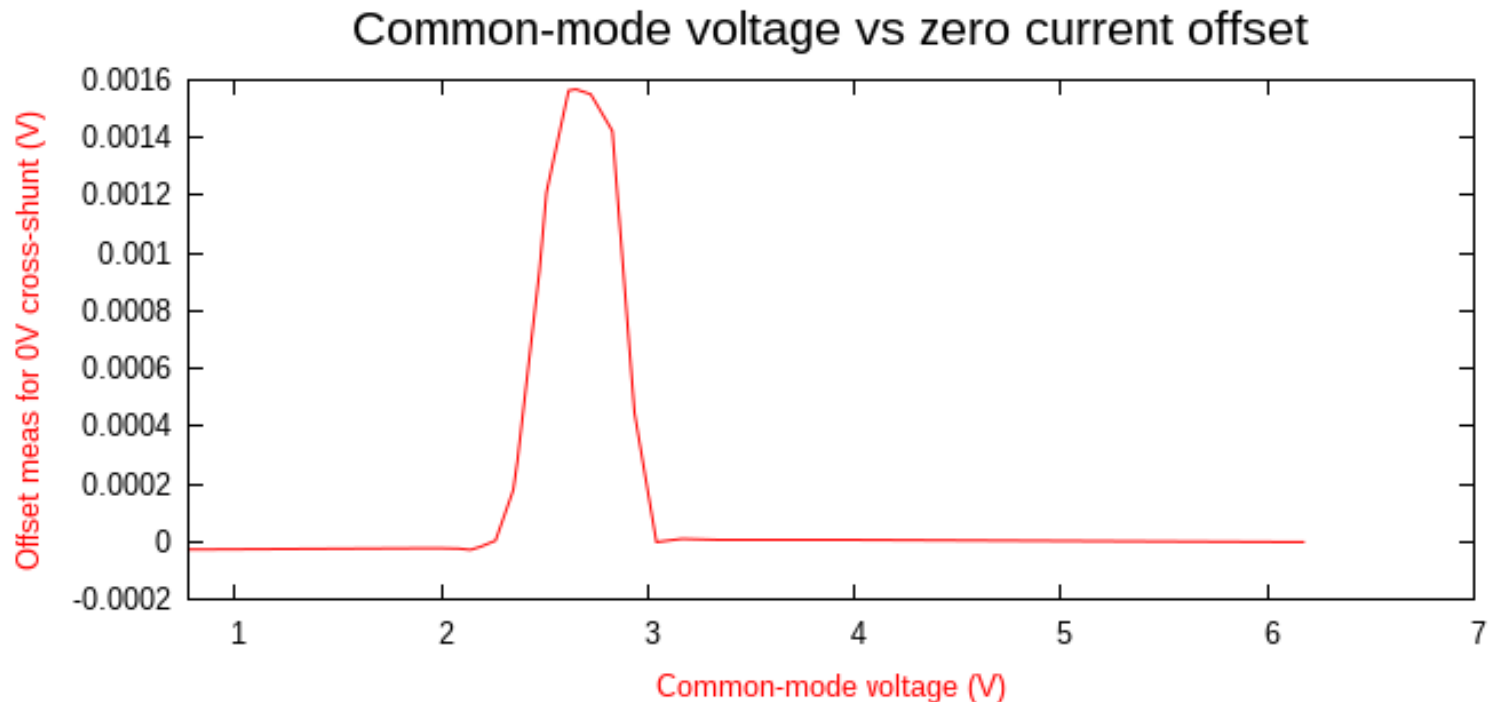

Correction model

- Software has table of “actual vs measured” cross-shunt voltages at different common-mode voltages
 - This calibrates against all the common-mode anomalies and nonlinearities
 - Common-mode related error is actually critical
- Checks table to find nearest known measurements either side of current measurement and interpolates

Ch2 Correction offsets (0-165mV)

-

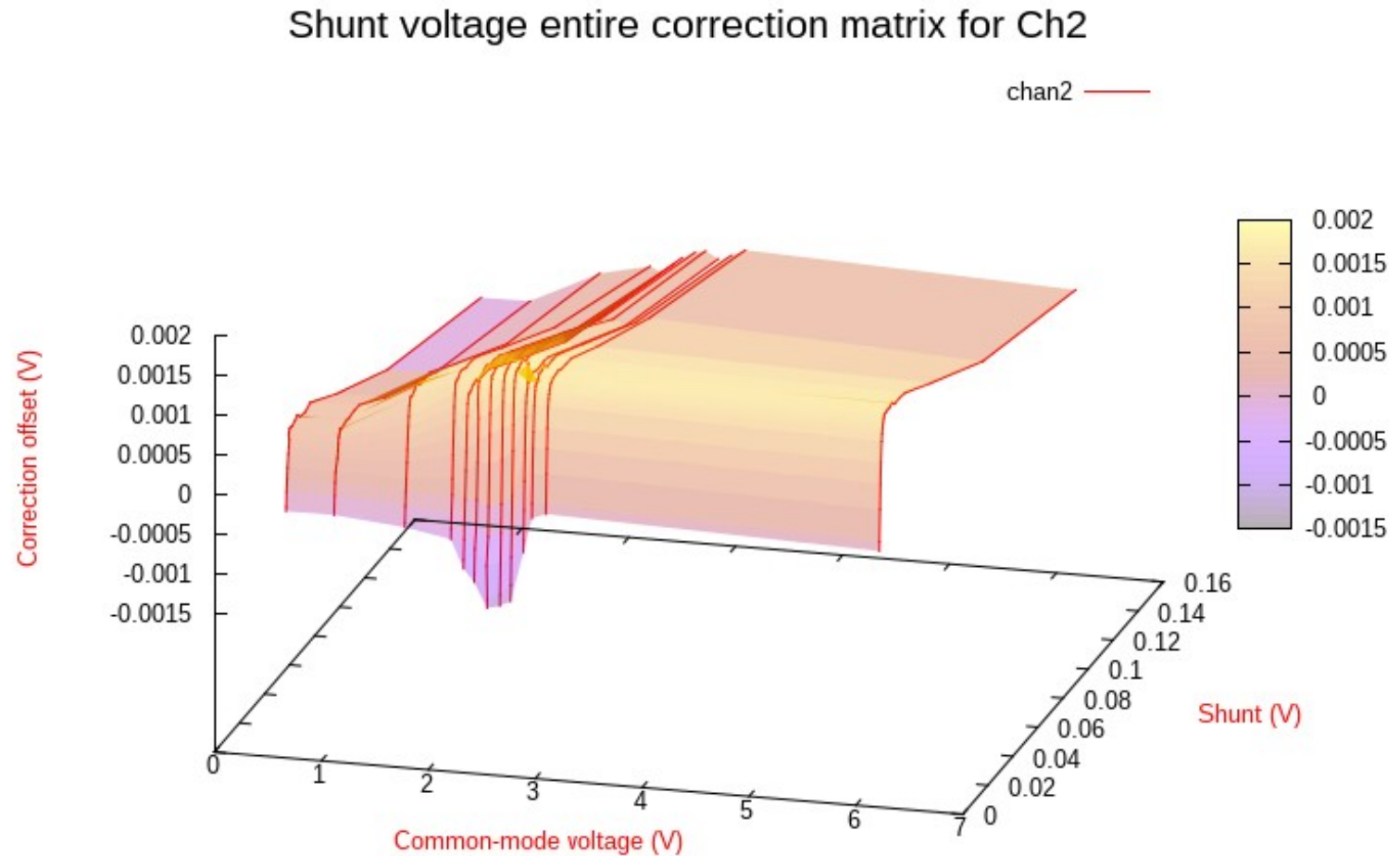

Correction offset map (0-15mV)

-

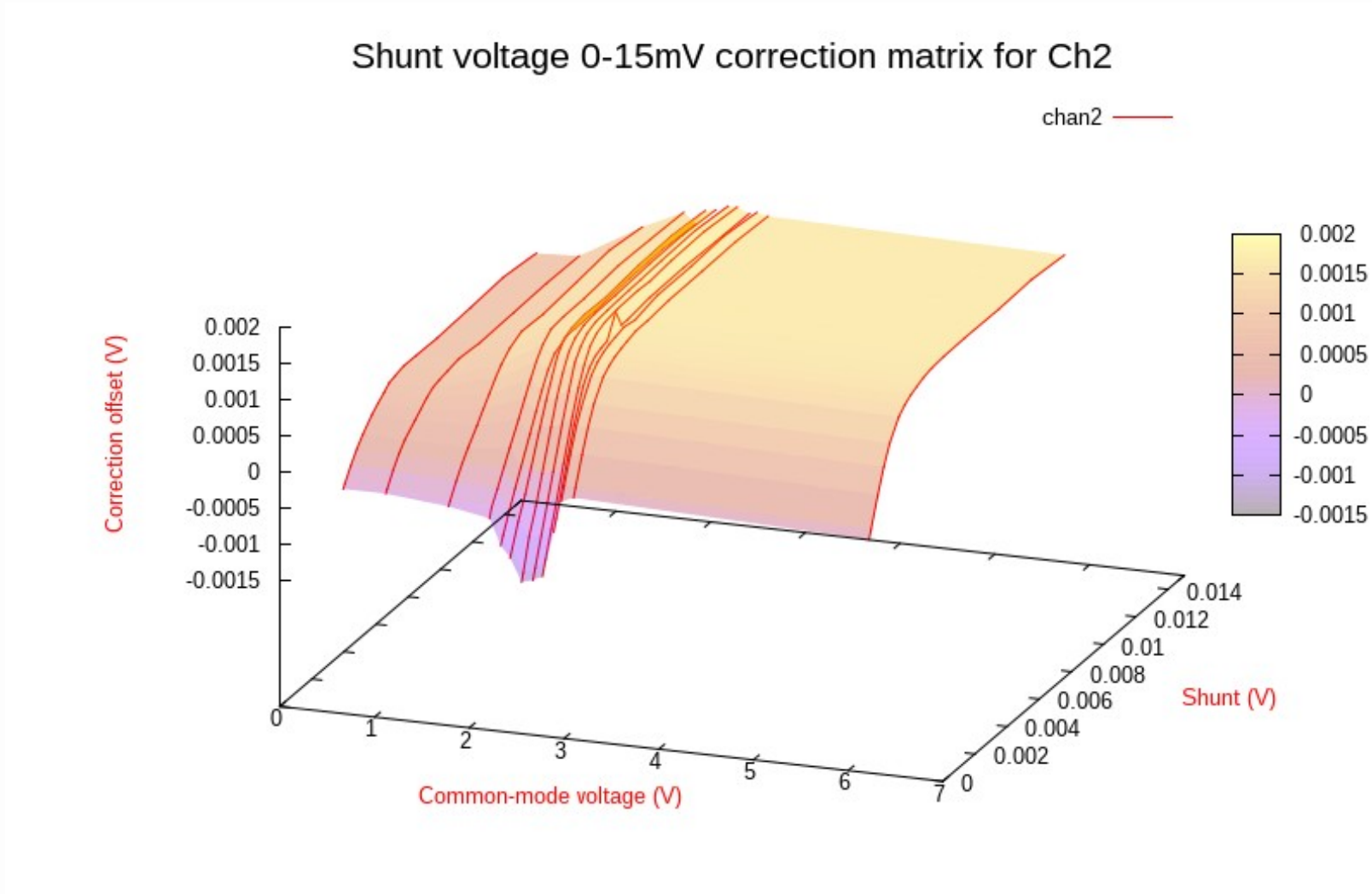

Actual transfer functions (0-7.5mV)

-

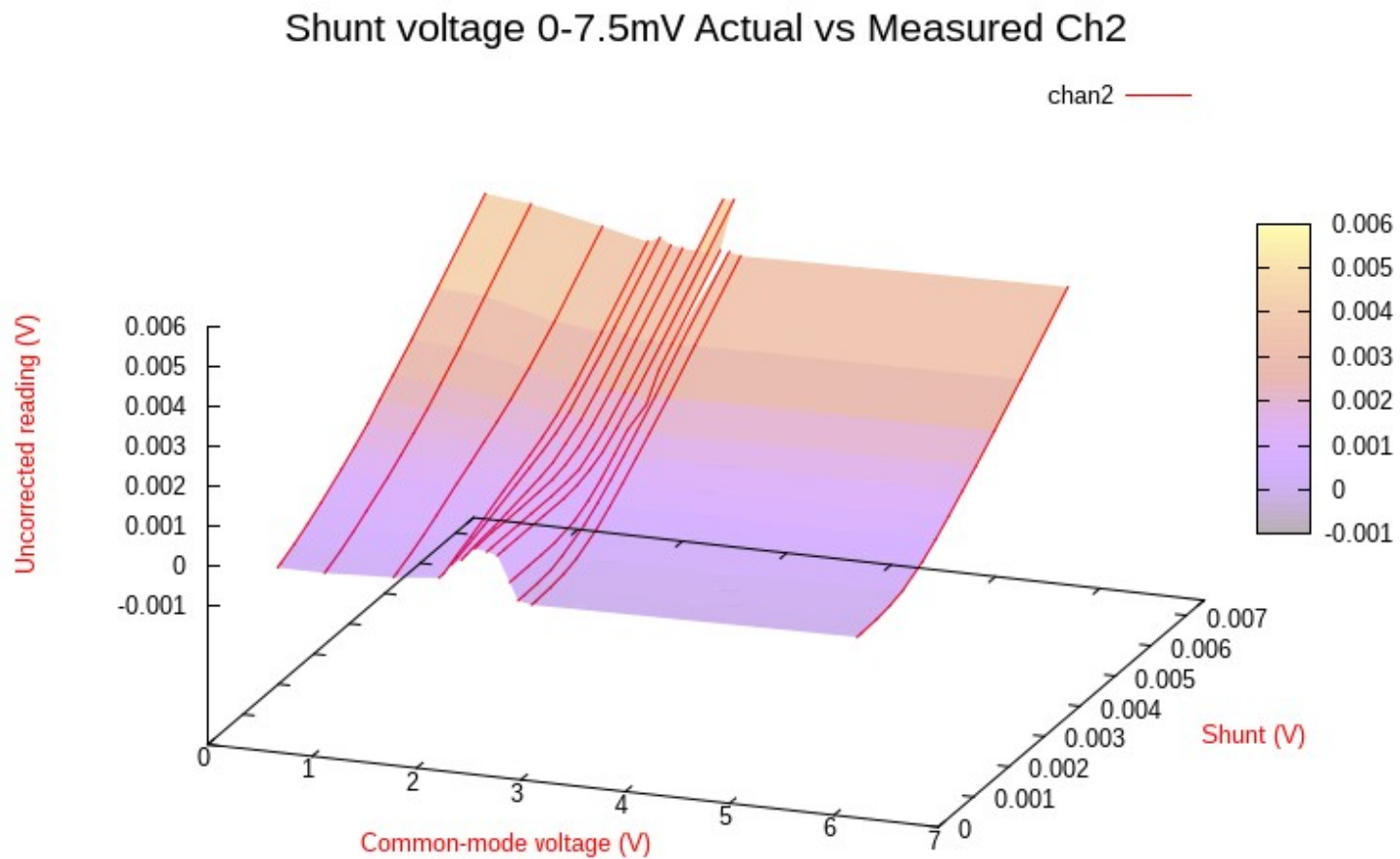

Actual transfer functions (0-7.5mV)

-

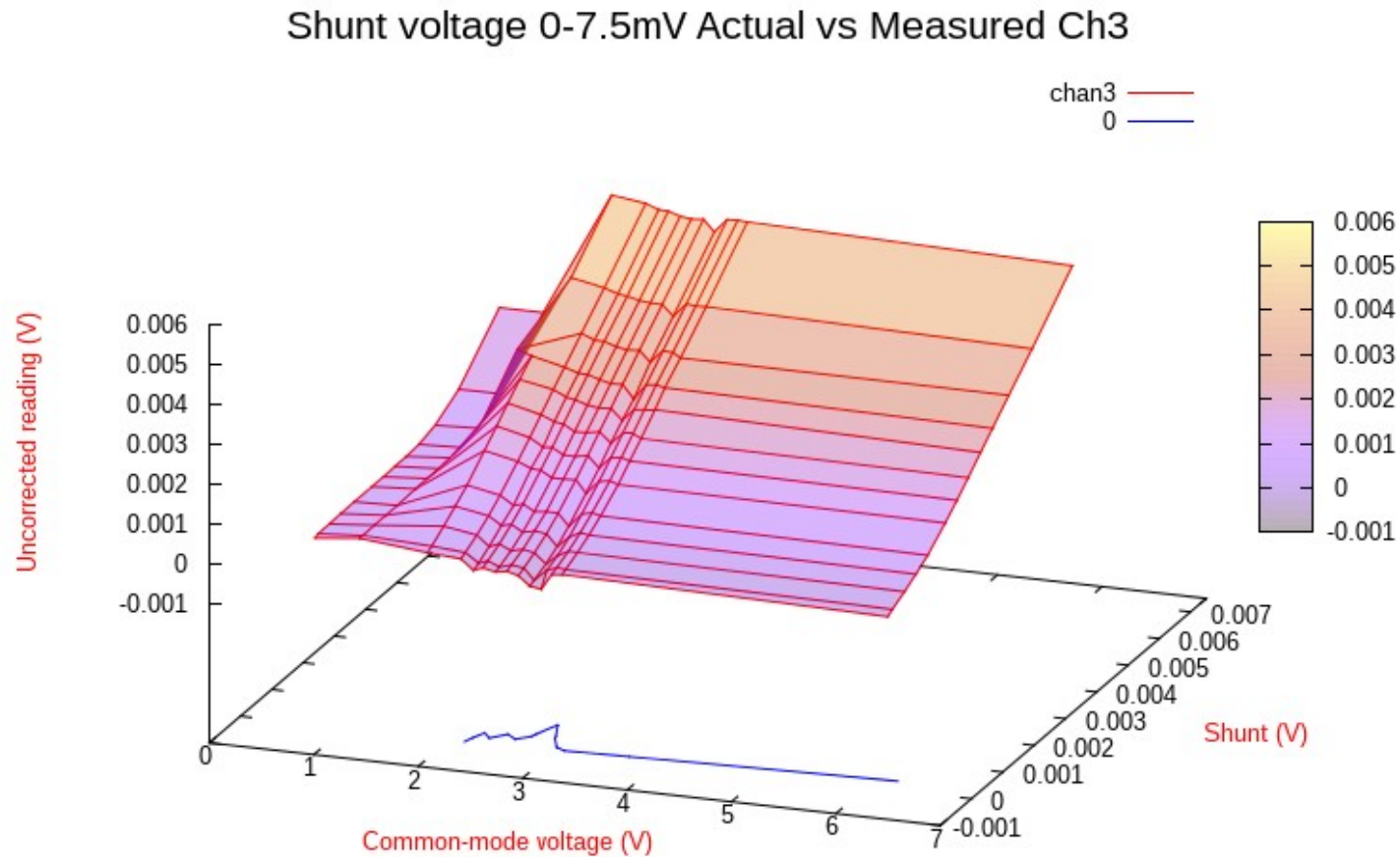

Actual transfer functions (0-7.5mV)

-

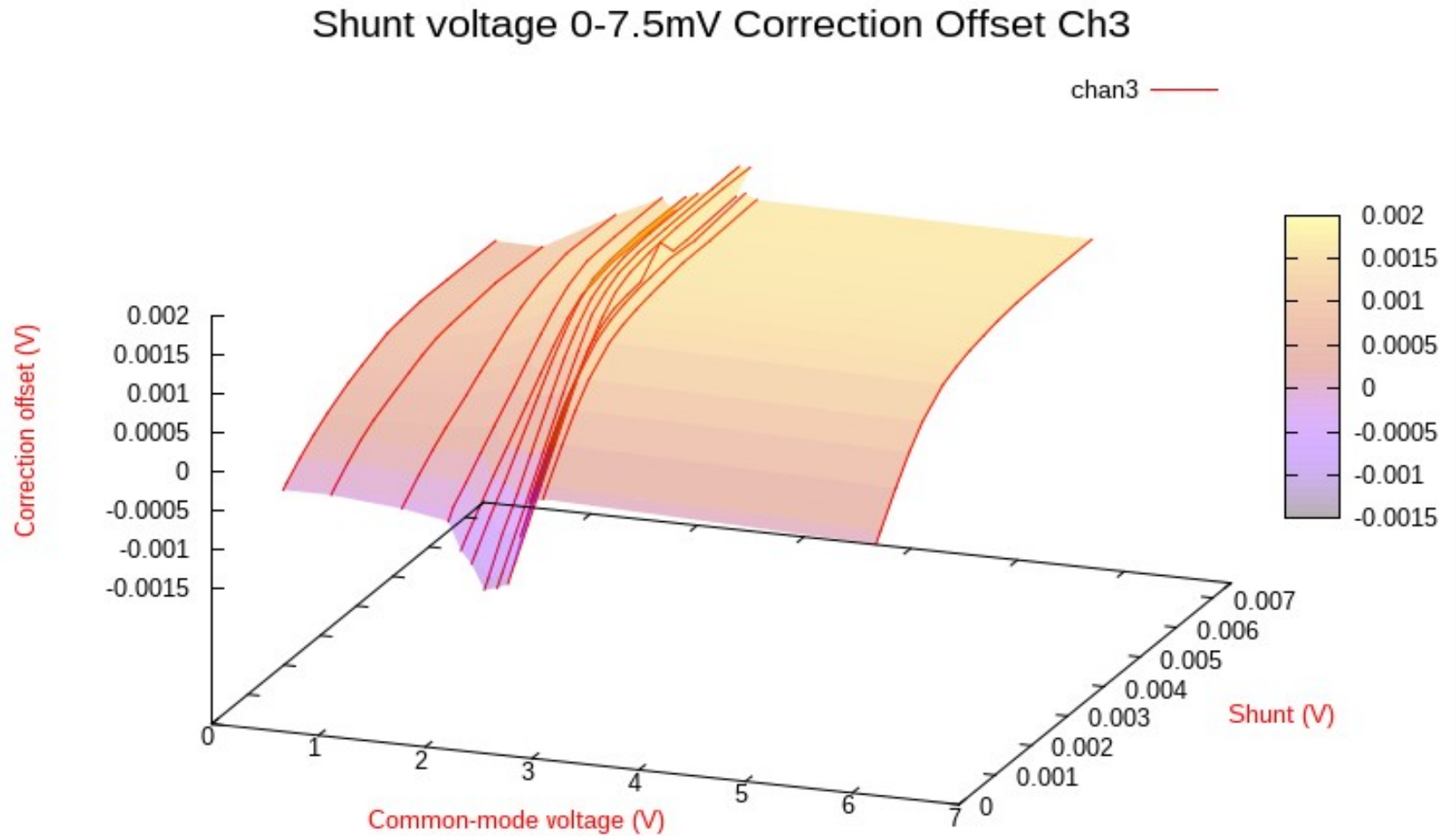

Correction model

- Software can also measure channels when shorted to 0V, and store these autozero offsets and noise estimates for voltage and current measurements per channel stored in config file
 - Perform autozero with sense leads shorted to 0V before doing measurement series
 - Try to keep temperature stable during measurements

Correction Effectiveness (ch1)

- No data to repair at $< 2\text{mV}$ across shunt
 - Uncorrected slope too flat near 0V to measure

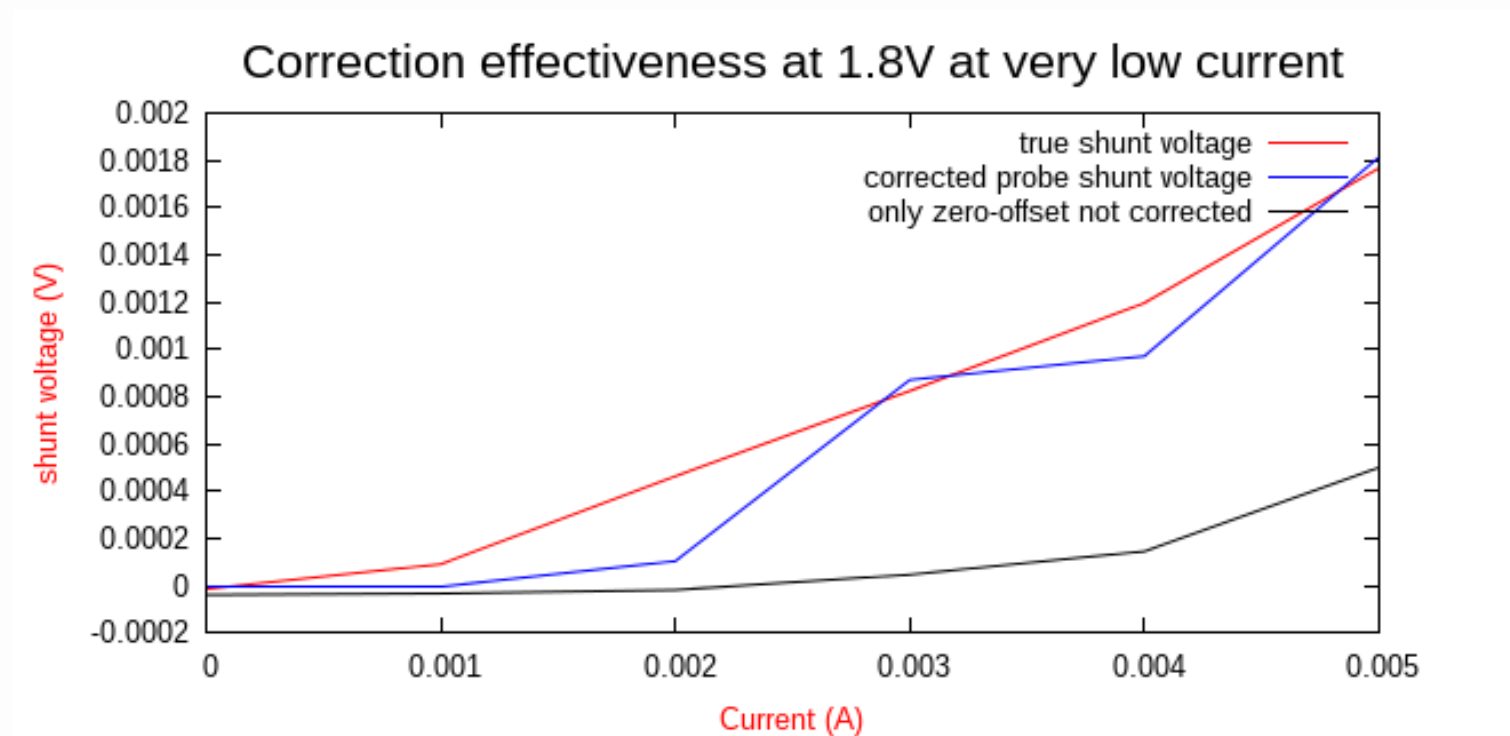

Correction Effectiveness (ch1)

- At $>2\text{mV}$ across shunt, correction effective
 - Flat nonlinearity exists only near 0V

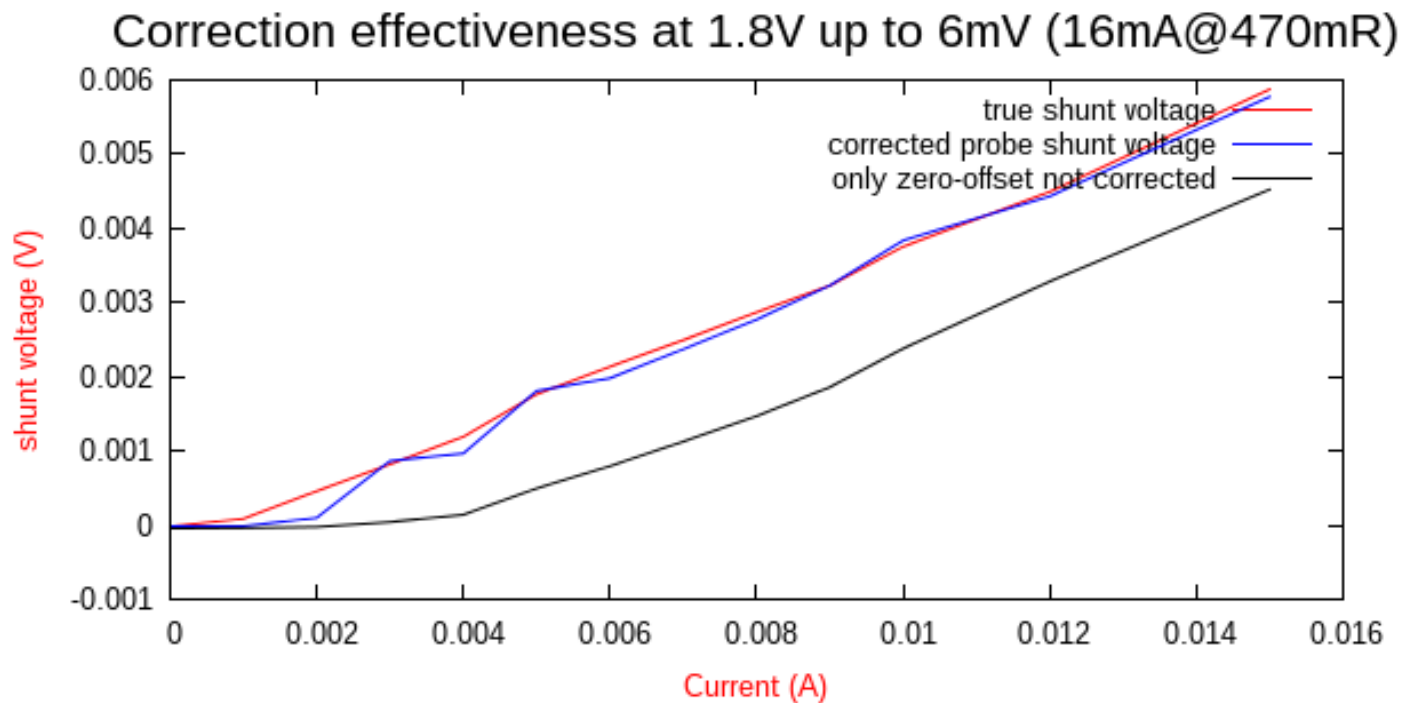

Low current measurements

- Probe (ch1) unable to measure $< 2\text{mV}$ across the shunt ($< 4\text{mA}$ @ $470\text{m}\Omega$ shunt)
- $4\mu\text{V}$ measured difference in shunt voltage between 0mA and 1mA load with $470\text{m}\Omega$ shunt (should be $470\mu\text{V}$ per mA)
 - Problem caused by flat, nonlinear response near 0V shunt voltage
 - 10°C temp change causes $>1000\mu\text{V}$ drift by comparison, **$4\mu\text{V}$ is lost in 0V offset drift**

Low current measurements

- Increasing shunt value helps a bit
 - With 1R shunt, $> 2\text{mA}$ OK, limited to 165mA; 2R shunt down to 1mA OK, limited to 82mA
 - High value shunts may cause difficulties at input side of switching regulators
 - Try adding 10uF+ ceramic cap after shunt if so
- Hard to get good numbers for suspend on normally high-current (low Rshunt) rails
 - Conflicting requirements on Rshunt selection

Correction Effectiveness

- Linearity and accuracy improve at higher shunt voltages up to 165mV maximum
 - Graph hides the mess down near 0 😊

Correction effectiveness at 1.8V and shunt voltage whole range

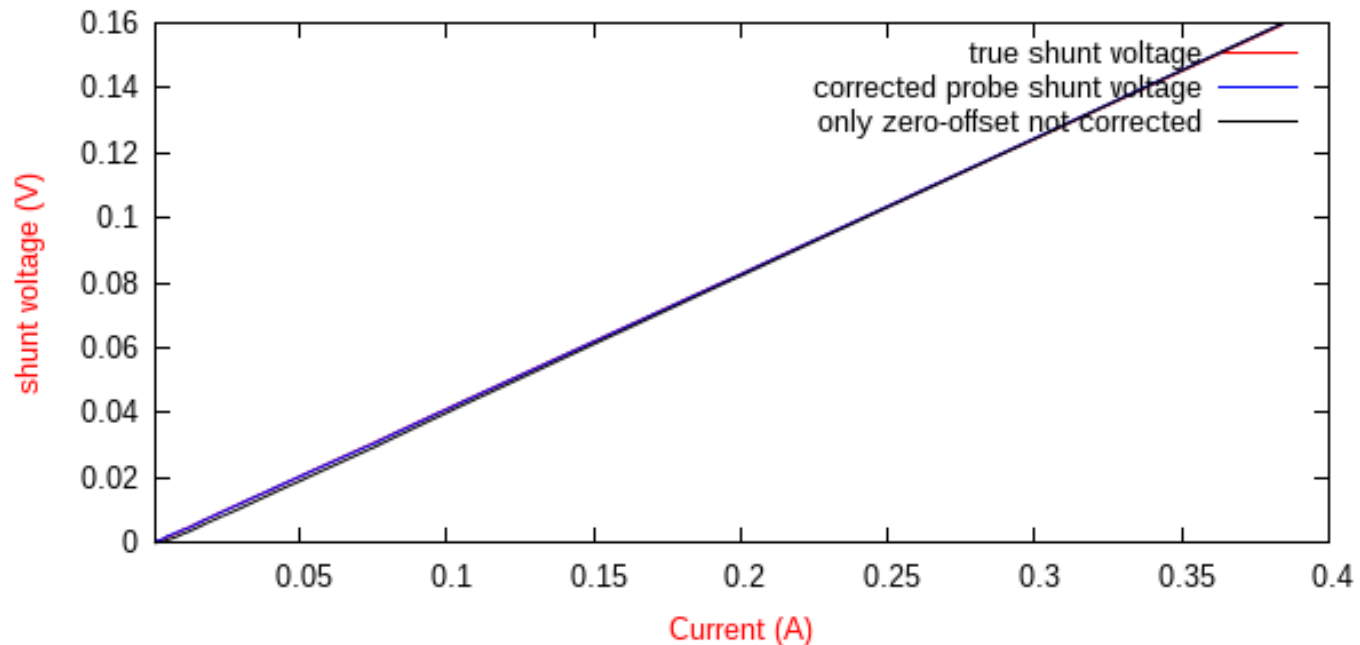

Differences between channels

- Uncorrected (except zero offset) measurement on 12 channels of 4 probes for same 3.829mV shunt voltage (red line)

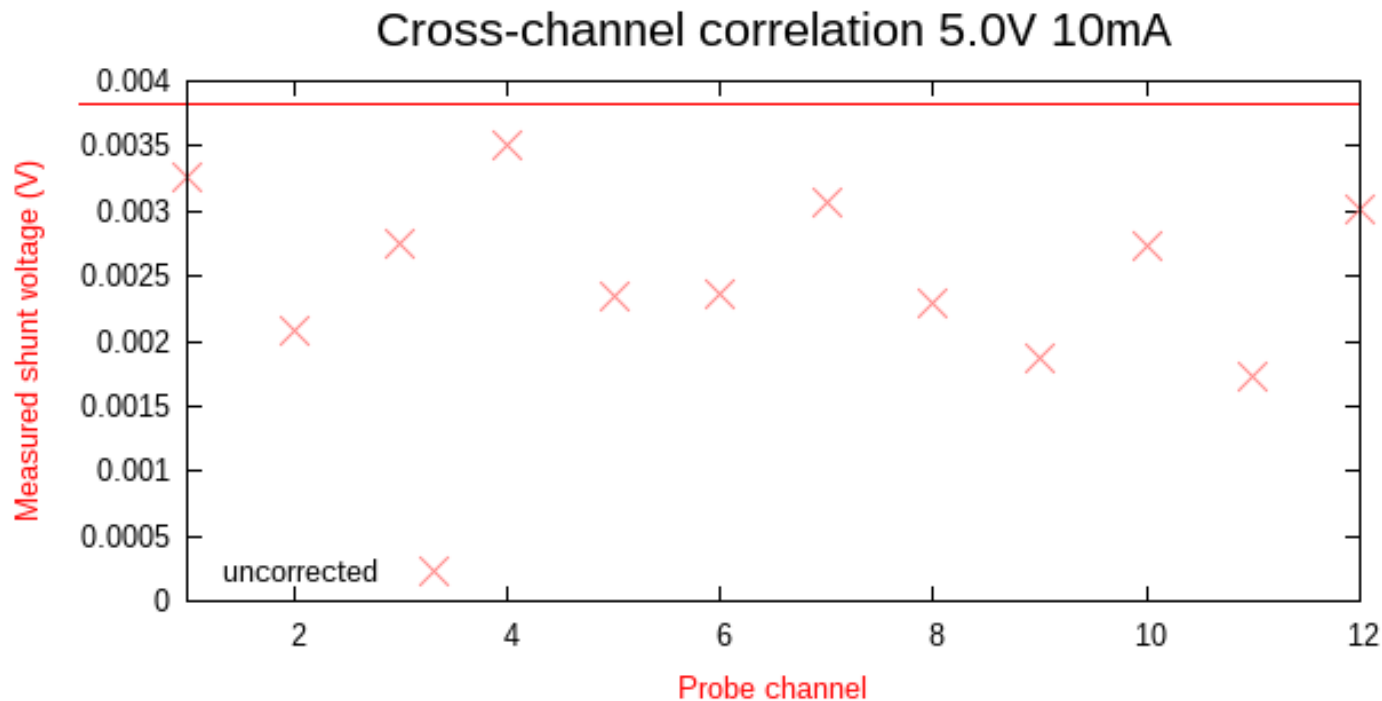

Differences between channels

- 1.8mV spread of results for same 3.8mV measurement, just by using different channels... >47% error...
- Common-mode voltage detection was fine with spread of only 105mV (2%) for 5.0V measurement over 12 channels, just differential shunt voltage measurement affected

Differences between channels

- Spread at higher shunt voltage (41.05mV red line) narrows, worst error -5%

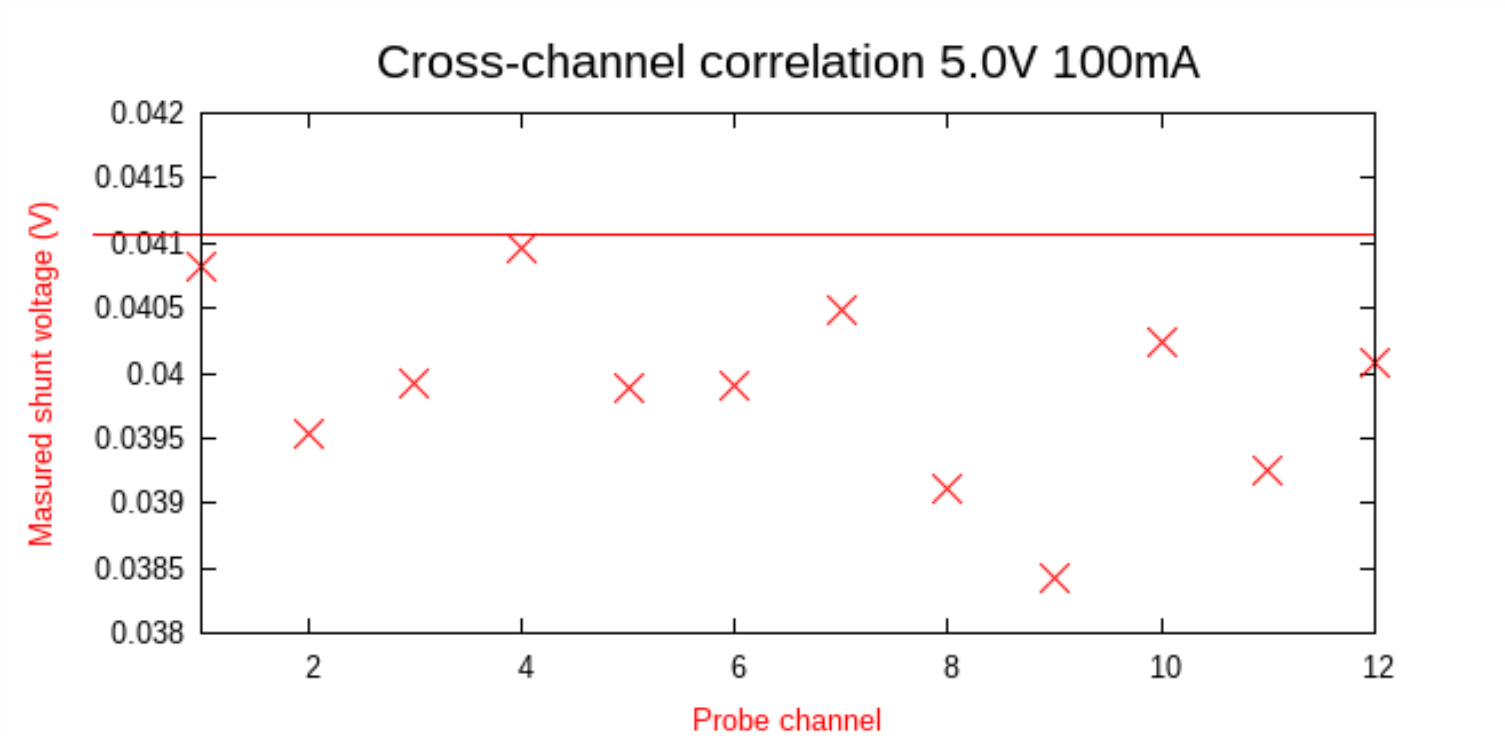

Channel correlation correction

- Detailed correction maps taken from channels 1 – 3 stored in software
- Channel config contains % uncorrected error at 3.8mV shunt voltage
 - User needs to measure it on each channel
- Software selects “nearest” correction map from ch1 (-14.5%), ch2 (-45%) or ch3 (-27.5%) for each channel.

Channel correlation correction effectiveness

- Selected ch1-3 detailed correction maps
 - Error less than -13%/+9% at 3.8mV

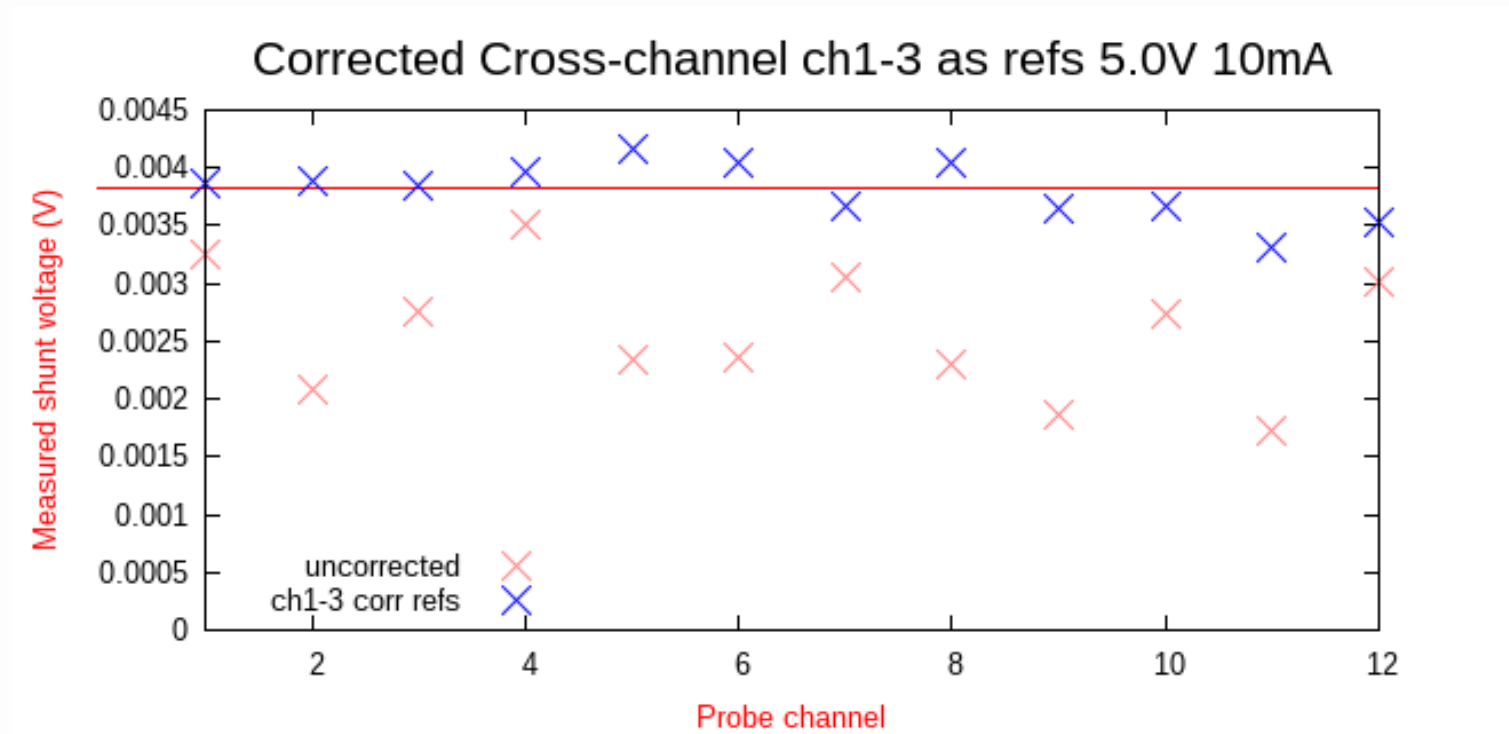

Channel correlation correction effectiveness

- Selected ch1-3 detailed correction maps
 - Error less than +/- 1.2% at 41mV

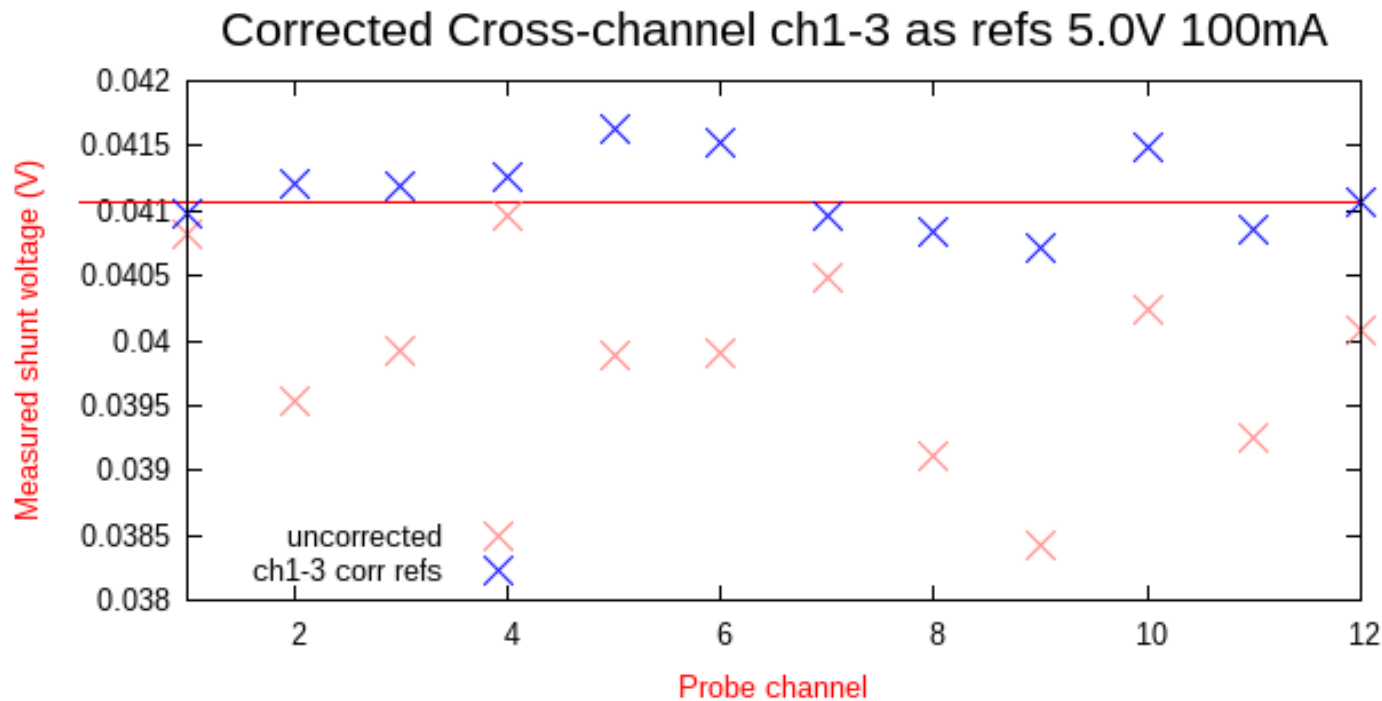

Cross-channel calibration procedure

- For each channel, Autozero then
 - Use 470mR shunt in series with ~500R load (not mR!), and apply 5V: ~3.8mV should appear across the shunt
 - Measure the shunt voltage with a multimeter if possible to make error calculation more accurate
 - Measure channel using -r (raw) and note uncorrected shunt voltage measured
 - Add % error from real shunt voltage to config
 - If measurement is lower, use negative number

Shunt tolerance error

- All errors mentioned independent of shunt
- Also actual shunt resistance is not known precisely
 - Typically +/- 1% or 5% at room temp
 - Also varies with temperature
 - At high currents, may self-heat
 - Not typically a problem with our situation
 - Error here directly affects current and power calculations

Summary

- Autozero before measurements
- Keep temperature stable
- Don't believe current measurements below a few mA, they are likely bogus
- Correction deals with most internal error sources, inter-channel correlation needs measurement and entry in config file
- Treat current measurements as +/- 10%

Arm Energy Probe Basics

- What it is
- Quick electronics 101 recap
- Measuring around regulators
- Wiring your board for AEP usage
- Some actual measurements
- Major sources of measurement error
- **Linux Commandline tool**

Linux arm-probe commandline tool

- Scripting and gnuplot-friendly
- Output on stdout (info on stderr)
 - Gnuplot style ascii floating point
 - Sample# volts amps watts (default) or
 - Sample# watts (--justpower / -j)
- If previous output piped into stdin, adds column
 - Friendly for combining multiple runs
 - Sample# watts1 watts2

Config file

- By default, ./config, # for comments
- First non-comment line is name for setup the config represents, eg, PandaES-B1-ANDY
- Then device path like /dev/ttyACM0
 - Followed by 3 x channel setups indented by space
 - <space> <channel name> <Rshunt> <Vslope> <Voffset for current> <fixed pretrigger> <"pretty name">

Config file

- Example config file
 - PandaBoardES-B1-ANDY
 - /dev/ttyACM0
 - VDD_VCORE1 0.470 1 -0.000253 0 VCORE1/MPU
 - VDD_VCORE2 0.470 1 -0.000262 0 VCORE2/IVA_AUDIO
 - VDD_VCORE3 0.470 1 -0.000304 0 VCORE3/CORE
- Space indent at start of channel lines is critical!
- Can define multiple probes in one config

Channel Autozero

- `--autozero / -z` takes 5s average on selected channel and writes the voltage and current seen into config for that channel
 - `arm-probe -c VDD_VCORE1 -z`
- During this, short both channel sense lines to 0V line so you are measuring 0V, 0A offset
 - Unfortunately the offset varies by channel and temperature...

Auto zero tracking

- `--autozero / -z` also estimates voltage noise
- During normal captures, after applying the zero offset correction, if samples below 0 are seen, it may adapt the offset
 - If the negative sample is outside the noise range
 - If we have been sampling for a little while
 - Zero level offset changed by 10% of the deltas
 - Cannot do same trick for offset decreases

Channel names

- Select the channel you will capture using the channel name from the first config column
 - `--channel / -c <channel name>`
 - If you have multiple probes, will find the correct probe according to `/dev/ttyACM` section in config
 - Take care to connect probes to USB in same order
 - “Pretty name” is used for channel in output
 - Gnuplot needs `'_'` to be `'_'` in pretty name

Channel names

- You can give -c multiple times
- You can simultaneously capture from one channel per probe
 - No matter how many probes you use, and how many channels, you can capture all channels in no more than 3 runs

Trigger threshold and filtering

- Specify “trigger” threshold in mV or mW
 - In volts (`--mvtrigger / -q <mV>`), and / or
 - In power (`--mwtrigger / -w <mW>`)
 - Default, 400mV, 0mW
- Specify how long trigger must remain true to be accepted (`--ustrigfilter / -f <us>`)
 - Default, 400us (four samples)
 - 200mV / mW hysteresis applied

Pretrigger

- Until trigger conditions seen, probe in “pretrigger” state
 - Nothing on stdout
 - Displays live volts / amps / watts on stderr
- Can capture to pretrigger buffer so you can see what led up to trigger event
 - (`--mspretrigger / -p <ms to capture>`)
 - Pretrigger buffer flushed on stdout first

Trigger holdoff

- Amount of time to wait after trigger event seen before actually triggering
 - `--mstrighold / -t <ms>`
 - Default 0ms
 - Allows you to target events that occur a fixed period after, eg, power-on, without capturing everything before

Capture length and autoexit

- Can define how long to capture data
 - **--mslength / -l <ms>** (default: no limit)
 - Needed when combining captures on stdin
 - **--exitoncap / -x** exits the program when this capture limit is reached
 - **--offexit / -o** waits for trigger conditions to be false before exiting the program
 - Perfect to sync multiple scripted captures so next capture can trigger at power-on

Averaging

- Can apply mean averaging
 - `--mean / -m <samples>` (default: none)
 - Use with a large mean buffer to get single figure results instead of graph data
 - Ten samples per ms, so `-m 50000 -l 5000` gives perfectly mean-averaged 5s capture
 - Set your device to loop performing use-case
 - Choose a capture interval several times one loop period for best accuracy

Averaging

- Append a simple average to results
 - `--average / -a <secs (float)>` (default: none)
 - This is separate from the mean averaging
 - Even if you are not averaging the actual results, you can use this to get two extra results added at the end
 - These start from the time given (eg, 5.2) in seconds, which should be at or after the end of samples
 - With gnuplot, provides averaged “bars” on right

Decimation

- Reduces output to once per n samples
 - **--decimate / -d <samples>** (default: 1)
 - Allows long period monitoring of rails without being overwhelmed by data
 - Can be combined with mean averaging, eg **-m 50000 -d 50000** issues one new fully averaged sample every five seconds
 - **Sample#** in output still counts real input samples, so you can follow real time

Multicapture helper scripts

- Two common multichannel capture cases supported by scripts
 - **aep-capture.sh** - capturing on all channels during or after boot for fixed period
 - Manages observing power cycling of target for each channel and synchronizing captures
 - **aep-zero.sh** – autozeros every channel
 - Assumes no current across shunt and no voltage compared to 0V, eg, all short to 0V

Gnuplot scripts

- Gnuplot scripts will need customizing for your setup but have the basics
 - aeplot-average -
 - (continued next time...)